



SB101-TU

**Storage Barebone
User's Manual**

Document Release History

Release Date	Version	Update Content
September, 2022	1	Released to public.

Table of Contents

Preface	i
Safety Instructions	ii
About This Manual	iv
Chapter 1. Product Features	1
1.1 Box Contents	1
1.2 Specifications	2
1.3 System Block Diagram	3
1.4 Features	4
Chapter 2. Hardware Setup	7
2.1 Central Processing Unit	7
2.1.1 Installation	7
2.2 System Memory	12
2.2.1 Placement	12
2.2.2 DIMM Population	13
2.2.3 Installation	14
2.3 Top Cover	15
2.4 Power Supply Unit	16
2.4.1 Installation	16
2.4.2 LED Indicator	16
2.5 Fan	17
2.6 Disk Drive	18
2.6.1 Disk Drive: 2.5-inch (NVMe/SATA)	18
2.6.2 LED Indicator	19
2.6.3 Drive Slot Map	20
2.7 M.2 SSD (NGFF) Card	21
2.8 Riser Card	22
2.9 Slide Rail	23
Chapter 3. Hardware Settings	30
3.1 Block Diagram	30
3.2 Placement	31
3.3 Content List	32
3.4 External Port	34
3.5 Connector Definition	35
3.3.2 Connector	42
3.6 Jumper Definition	47
3.7 Internal LED	54
3.8 Drive Backplane: 4 Bay	55
3.8.1 Placement	55

3.8.2 Connector	55
3.8.3 LED Indicator	57
3.8.4 Cable Routing	58
Chapter 4. BIOS Configuration Settings	59
4.1 Navigation Keys.....	59
4.2 BIOS Menu	60
4.2.1 Menu	60
4.2.2 Startup	60
4.3 Main	61
4.3.1 Main	61
4.4 Advanced	62
4.4.1 Trusted Computing	62
4.4.2 Serial Port Console Redirection	63
4.4.3 SIO Configuration.....	63
4.4.4 PCI Subsystem Settings	63
4.4.5 USB Configuration.....	63
4.4.6 Network Stack Configuration	64
4.4.7 T1s Auth Configuration.....	64
4.4.8 RAM Disk Configuration.....	64
4.4.9 Driver Health	64
4.5 Platform Configuration	65
4.5.1 PCH Configuration	65
4.5.2 Server ME Configuration.....	67
4.5.3 Server ME Debug Configuration.....	67
4.5.4 Runtime Error Logging	68
4.6 Socket Configuration.....	69
4.6.1 Processor Configuration.....	69
4.6.2 Common RefCode Configuration.....	70
4.6.3 Memory Configuration	70
4.6.4 IIO Configuration	71
4.6.5 Advanced Power Management Configuration	72
4.7 Server Mangement	76
4.7.1 Processor Configuration.....	76
4.7.2 System Event Log.....	77
4.7.3 BMC Network Configuration.....	77
4.8 Security	78
4.9 Boot	79
4.10 Exit.....	80
4.11 BIOS Update Process.....	81
Chapter 5. BMC Configuration Settings	82

5.1 Login.....	82
5.2 Web GUI	83
5.2.1 Menu Bar.....	83
5.2.2 Dashboard	84
5.2.3 Sensor.....	85
5.2.4 System Inventory.....	85
5.2.5 FRU Information	86
5.2.6 Log & Reports.....	87
5.2.7 Settings.....	88
5.2.8 Remote Control	89
5.2.9 Images Redirection	91
5.2.10 Power Control.....	92
5.2.11 Maintenance Group.....	93
5.2.11.1 Firmware Update.....	94
5.2.11.2 BIOS Firmware Update	99
5.2.12 Sign Out	102
Chapter 6. Technical Support.....	103



Copyright © 2022 AIC®, Inc. All Rights Reserved.

This document contains proprietary information about AIC® products and is not to be disclosed or used except in accordance with applicable agreements.

Preface

Copyright

No part of this publication may be reproduced, stored in a retrieval system, or transmitted in any form or by any means, electronic, mechanical, photo-static, recording or otherwise, without the prior written consent of the manufacturer.

Trademarks

All products and trade names used in this document are trademarks or registered trademarks of their respective holders.

Changes

The material in this document is for information purposes only and is subject to change without notice.

Warning

1. A shielded-type power cord is required in order to meet FCC emission limits and also to prevent interference to the nearby radio and television reception. It is essential that only the supplied power cord be used.
2. Use only shielded cables to connect I/O devices to this equipment.
3. You are cautioned that changes or modifications not expressly approved by the party responsible for compliance could void your authority to operate the equipment.

Disclaimer

AIC® shall not be liable for technical or editorial errors or omissions contained herein. The information provided is provided "as is" without warranty of any kind. To the extent permitted by law, neither AIC® or its affiliates, subcontractors or suppliers will be liable for incidental, special or consequential damages including downtime cost; lost profits; damages relating to the procurement of substitute products or services; or damages for loss of data, or software restoration. The information in this document is subject to change without notice.

Instruction Symbols

Special attention should be given to the instruction symbols below.



NOTE

This symbol indicates that there is an explanatory or supplementary instruction.



CAUTION

This symbol denotes possible hardware impairment. Upmost precaution must be taken to prevent serious hardware damage.



WARNING

This symbol serves as a warning alert for potential body injury. The user may suffer possible injury from disregard or lack of attention.

Safety Instructions

Before you commence, please attentively read the following important discretions below. All cautions and warnings on the equipment or in the manuals should be circumspactly noted and reviewed.

Always ground yourself to prevent static electricity.

請全程接地，以防止靜電。

请全程接地，以防止静电。

Всегда заземляйте себя, чтобы избежать статического электричества.

Aard jezelf altijd om statische elektriciteit te voorkomen.

- Firmly ground yourself at all times when installing or assembling the internal components of the server. Most of electronic components in the server are highly sensitive to electrical static discharge.
- Use a solid grounding wrist strap and distintively place all electronic components in static-shielded devices to prevent static. Grounding wrist straps can be purchased in any electronic supply store.
- Confirm that the power source is turned off and then disconnect the power cords from your system before performing any type of installation or manual servicing. A sudden surge of power could serverly damage the sensitive electronic components.
- Do not precipitously open the system's top cover. If you must open the cover for maintenance purposes, only a trained technician should be allowed to proceed this action. Integrated circuits on computer boards are highly sensitive to static electricity. Before operating a board or integrated circuit, touch an unpainted portion of the system unit chassis for a couple of seconds to discharge any static electricity on your body.

Place the server in a stable environment.

請將伺服器放置在穩定的環境中。

请将伺服器放置在穩定的環境中。

Поместите сервер в стабильную среду.

Plaats de server in een stabiele omgeving.

- Place this equipment on a stable surface when installing. A small mild drop or fall could cause fatal injury to both the equipment and the person handling the equipment.
- Please keep this equipment away from humidity to prevent vast rust and disintergration.
- Carefully and accurately mount the equipment into the rack. Uneven mechanical loading may lead to hazadous consequences.
- This equipment is to be installed for operation in an environment with maximum ambient temperature below 35°C.
- Review the environment before performing any installation or servicing. Keep the equipment away from hazardous and uneven grounds.
- This server must be installed only in Restricted Acss Locations.

Handle equipment with care.

請謹慎操作設備。

请谨慎操作设备。

Обращайтесь с оборудованием осторожно.

Behandel de apparatuur voorzichtig.

- Do not cover the openings of the system. The openings on the system are for air convection, which intentionally protect the equipment from overheating.
- Never pour any liquid into ventilation openings of the system. This could cause catastrophic fire or electrical shock.

- Ensure that the voltage of the power source is within the specification on the label when connecting the equipment to the power outlet. The current load and output power of loads must be within the specification.
- This equipment must be firmly connected to reliable grounding before usage. Pay special attention to power supplied other than direct connections, e.g. using of power strips.
- Place the power cord out of the way of foot traffic. Do not place anything over the power cord. The power cord must be rated for the product, voltage and current marked on the product's electrical ratings label. The voltage and current rating of the cord should be greater than the voltage and current rating marked on the product.

Pay attention to hardware maintenance.

注意硬體維護。

注意硬体维护。

Обратите внимание на обслуживание оборудования.

Besteed aandacht aan hardware-onderhoud.

- If the equipment is not used for a long time, disconnect the equipment from mains to avoid being damaged by transient over-voltage.
- Module and drive bays must not be empty. They must have a dummy cover.
- Never open the equipment without professional assistance. For safety reasons, only qualified service personnel should open the equipment.
- If one of the following situations arise, the equipment should be checked and tested by service personnel:
 1. The power cord or plug is damaged.
 2. Liquid has penetrated the equipment.
 3. The equipment has been exposed to moisture.
 4. The equipment does not work well or will not work according to its user manual.
 5. The equipment has been dropped and/or damaged.
 6. The equipment has obvious signs of breakage.
 7. Please disconnect this equipment from the AC outlet before cleaning. Do not use liquid or detergent for cleaning. The use of a moisture sheet or cloth is recommended for cleaning.



CAUTION

The equipment intended for installation should be placed in Restricted Access Location.



CAUTION

There will be a risk of explosion if battery is replaced by an incorrect type. Dispose of used batteries according to the instructions. After performing any installation or servicing, make sure the enclosure is correct in position before turning on the power.



CAUTION

This unit may have more than one power supply. Disconnect all power sources before maintenance to avoid electric shock.



About This Manual

Thank you for selecting and purchasing the SB101-TU.

This user's manual is provided for professional technicians to perform easy hardware setup, basic system configurations and quick software startup. This document pellucidly presents a brief overview of the product design, device installation and firmware settings for SB101-TU. For the latest version of this user's manual, please refer to the AIC® website: <https://www.aicipc.com/en/productdetail/51329>.

Chapter 1 Product Features

SB101-TU is a flexible storage server barebone that is specifically designed to accommodate diverse corporations and enterprises for managing heavy workloads and multiple applications.

Chapter 2 Hardware Setup

This chapter displays an easy installation guide for assembling the hardware in this product. Utmost caution for proceeding to set up the hardware is highly advised. Most of the components are highly fragile and vulnerable to exterior influence. Do not endanger the device by placing the device in an unstable environment.

Chapter 3 Motherboard Settings

This chapter elaborates the overall layout of the server motherboard, including multifarious connectors, jumpers and LED descriptions. These descriptions assist users to configure different settings and functions of the motherboard, as well as to confirm the placement of each connector and jumper.

Chapter 4 BIOS Configuration Settings

This chapter introduces the key features of BIOS, including the descriptions and option keys for diverse functions. These details provide users to effortlessly navigate and configure the input/output devices.

Chapter 5 BMC Configuration Settings

This chapter illustrates the diverse functions of IPMI BMC, including the details on logging into the web page and assorted definitions. These descriptions are helpful in configuring various functions through Web GUI without entering the BIOS setup. For more information of BMC configurations, please refer to IPMI BMC (Aspeed AST2500) User's Manual for a more detailed description.

Chapter 6 Technical Support

For more information or suggestion, please contact the nearest AIC® corporation representative in your district or visit the AIC® website: <https://www.aicipc.com/en/index>. It is our greatest honor to provide the best service for our customers.

Chapter 1. Product Features

SB101-TU is a high density storage server that includes motherboard, chassis, power supply and disk drive. For more information about our product, please visit our website at <https://www.aicpc.com/en/index>.

Before removing the subsystem from the shipping carton, visually inspect the physical condition of the shipping carton. Exterior damage to the shipping carton may indicate that the contents of the carton are damaged. If any damage is found, do not remove the components; contact the dealer where the subsystem was purchased for further instructions. Before continuing, first unpack the subsystem and verify that the number of components in the shipping carton is accurate and in good condition.

1.1 Box Contents

This product contains the components listed below.

Please confirm the number and the condition of the components before installation.

Pre-installed into the system		Number
✓	750W/1100W redundant power supply 80+ Platinum	1+1
✓	2.5-inch/3.5-inch hot swap disk drive tray	4
✓	Easy swap fan 6 x 40x56mm	6
✓	Fan 1 x 40x28mm	1
✓	AIC® Tucana motherboard	1
Accessory Item		Number
✓	Heat sink	2
✓	EPE foam for front board: 575*420*105H	1
✓	EPE foam for rear board: 575*420*105H	1
✓	EPE foam for front tray: 575*300*145H	1
✓	EPE foam for rear tray: 575*300*145H	1
✓	EPE pad(Rail Box): 125*100*55H	2
✓	EPE pad: 125*115*100T	2
✓	Power cord	vary per region
✓	28-inch tool-less slide rail assembly	1

Product features are subject to change without notice.

1.2 Specifications

Dimensions (W x D x H)	mm : 438 x 678.7 x 43.5			System BIOS	BIOS Type	AMI UEFI BIOS	
	inches : 17.2 x 26.7 x 1.7				BIOS Features	<ul style="list-style-type: none"> • ACPI • PXE • AC loss recovery • IPMI KCS interface • SMBIOS • Serial console redirection • SRIOV • TPM • PCIe Hotplug 	
Motherboard	AIC Server Board Tucana						
Processor	Processor Support	<ul style="list-style-type: none"> • 3rd Gen Intel® Xeon® Scalable Processors (Ice Lake) • Supports CPU TDP up to 270W* <i>*Please contact AIC Technical Support for more info/details about optimized CPUs and specialized system.</i>					
	CPU Interconnection	10.4 / 11.2 GT/s					
	Socket Type	Socket P+ (LGA-4189)					
Chipset Support	Intel® C621A Chipset				On-board Devices	SATA	Lewisburg PCH on-chip solution supports 10 x SATA 6.0 Gb/s 2 x SATA 7pin 8 x SATA by slimline (supports both SATA/PCIe by PCH HSIO)
System Memory	<ul style="list-style-type: none"> • 8 x memory channels per CPU (1DPC) • 16 x DIMM slots support: DDR4 3200/2933MHz RDIMM/LRDIMM - up to 512GB RDIMM SRx4 (16Gb) - up to 1024GB RDIMM DRx4 (16Gb) - up to 4096GB RDIMM 3DS 8Rx4 (16Gb) - up to 2048GB LRDIMM QRx4 (16Gb) - up to 4096GB LRDIMM 3DS 8Rx4 (16Gb) • Intel® Optane™ DC Persistent Memory (Barlow Pass) support 					IPMI	Aspeed AST2500 Advanced PCIe Graphics & Remote Management Processor • Baseboard Management Controller • Intelligent Platform Interface 2.0 (IPMI 2.0) • iKVM, Media Redirection, IPMI over LAN, Serial over LAN • SMASH Support • HTML5 • Redfish
	Front Panel	<ul style="list-style-type: none"> • System power • System reset 	<ul style="list-style-type: none"> • System ID • 2 x USB 3.2 Gen1x1 Type A 				
LEDs	<ul style="list-style-type: none"> • Power status • HDD activity • LAN activity 	<ul style="list-style-type: none"> • System ID • Warning 	Network Controllers			Realtek RTL8211E GbE for BMC dedicated management port (NCSI shared NIC - reserved for OCP & I210 by jumper setting)	
Drive Bays	External	3.5"/2.5" hot swap		4 (6G SATA/12G SAS/PCIe x4 NVMe)			
	Internal	2.5" OS		2			
Backplane	1 x 4-port SATA/SAS/NVMe backplane with 1 x SFF-8643 + 2 x SFF-8654 (Slimline 8i) connectors			Graphics		Aspeed AST2500 Advanced PCIe Graphics & Remote Management Processor • PCIe VGA/2D Controller • 1920x1200@60Hz 32bpp	
	Expansion Slots	PCIe 4.0	CPU0: 2 x PCIe Gen4 X16 slots + 1 x OCP V3.0				
Rear I/O	LAN	1 x GbE RJ45 dedicated to BMC management				System Management	<ul style="list-style-type: none"> • IPMI : Aspeed AST2500 Advanced PCIe Graphics & Remote Management Processor • Baseboard Management Controller • Intelligent Platform Interface 2.0 (IPMI 2.0) • iKVM, Media Redirection, IPMI over LAN, Serial over LAN • SMASH Support
	USB	2 x USB 3.2 Gen 1x1 Type A in double-stack connectors					
	VGA	1 x VGA DB15					
	Serial Port	1 x external COM port phone jack					
TPM Support	2.0 onboard			Environmental Specifications	<ul style="list-style-type: none"> • Storage temperature: -10°C(14°F) ~ 60°C(140°F) • Operating temperature: 0°C(32°F) ~ 35°C(95°F) • Storage operating humidity: 5%~95% non-condensing 		
Power Supply	750W/1100W 1+1 redundant power supply 80+ Platinum						
System Cooling	<ul style="list-style-type: none"> • 6 x 40x56mm easy swap fans • 1 x 40x28mm fan 			Gross Weight	(w/ PSU & Rail)	kgs : 20	
	Mounting					lbs : 44	
Packaging Dimensions					Mounting	Standard	mm : 615 x 1025 x 274
							inches : 24 x 40 x 10.8

1.3 System Block Diagram

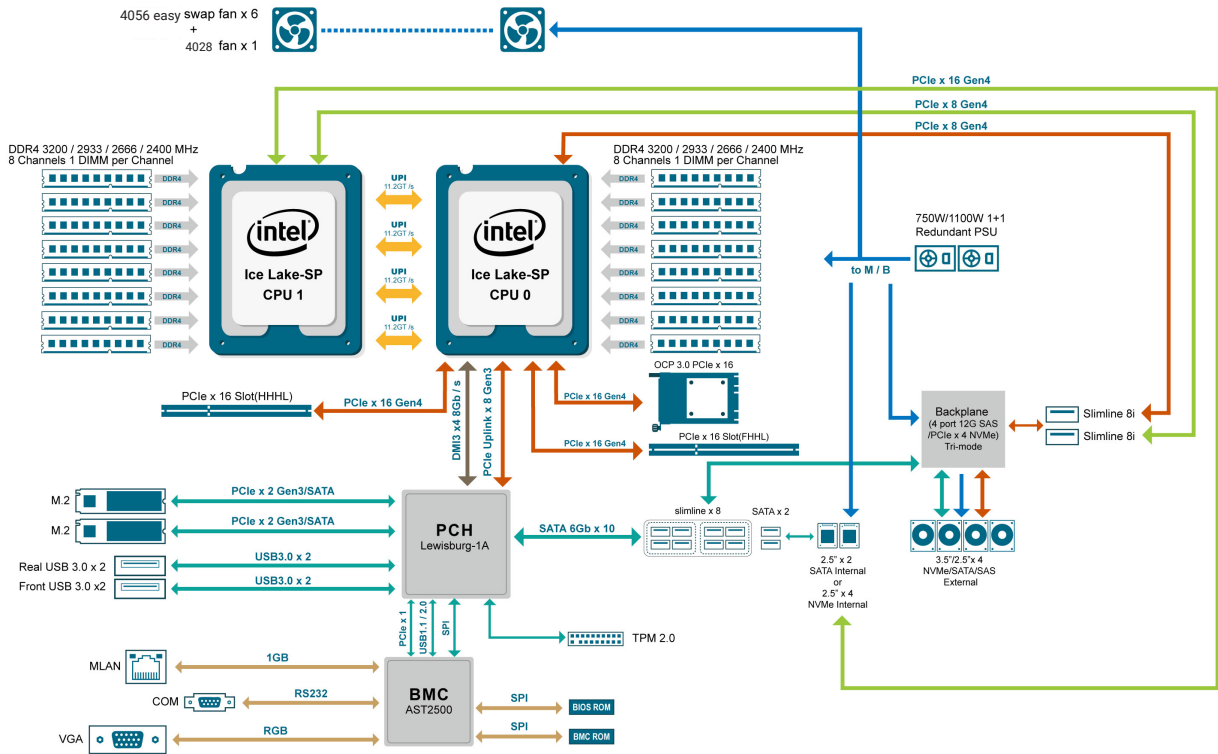

1.4 Features

SB101-TU is a reliable 1U storage server barebone with 4 hot swap drives bays. This product is designed to accommodate the AIC-patented serverboard, Tucana, which supports two Intel® Xeon® Scalable Processors and 16 DDR4 DIMM to offer greater performance, efficiency and utility for our customers. Featuring Intel® C621A Series Chipset, which is emphasized for its accelerated speed and expansion, this product enhances these advantages by integrating flexible IO usage and system expansion into to provide greater bandwidth and utilization.







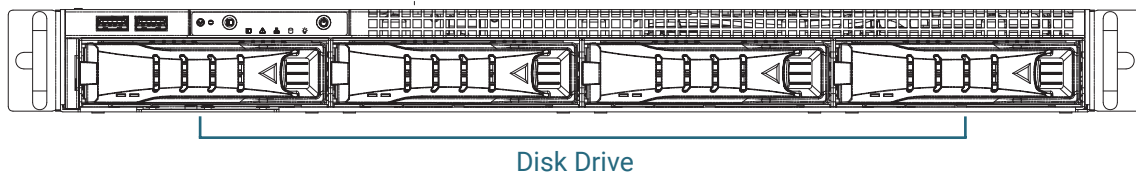

In addition to the noteworthy features of the barebone, SB101-TU provides immediate and efficient management with Onboard Baseboard Management Controller and greater I/O extension. Featuring IPMI 2.0 and Aspeed AST2500 Advanced PCIe Graphics, the server board offers support for iKVM, Media Redirection, Smash Support, IPMI over LAN and Serial over LAN.

- Supports 3rd Gen Intel® Xeon® Scalable Processors for highest server performance and improved power efficiency
- Supports 16 DDR4 DIMM slots for maximum memory performance
- Supports up to 2 x16 lanes, 4 slimline x8, 1 OCP 3.0 of PCIe Gen4 expansions
- Onboard Baseboard Management Controller for system management and IPMI control
- Embedded components for 5+ year long life

Front Panel



System LED Indicator and switch

Item	Description	Item	Description
	Power Button		LAN LED
	Power Status LED		System Reset Button
	Drive Activity LED		System Fault LED
	System ID Button		System ID LED

Rear Panel

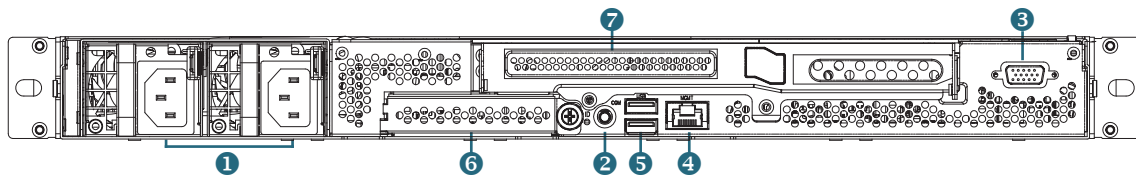

Item	Description
1	750W/1100W 1+1 redundant power supply 80+ Platinum
2	1 x external COM port phone jack
3	1 x VGA port
4	1 x GbE RJ45 dedicated to BMC management port
5	2 x USB 3.2 Gen1x1 Type A in double-stack port
6	OCP 3.0 slot
7	PCIe Gen4 x16 slot via riser card (HHHL Add-in Card)

Top View

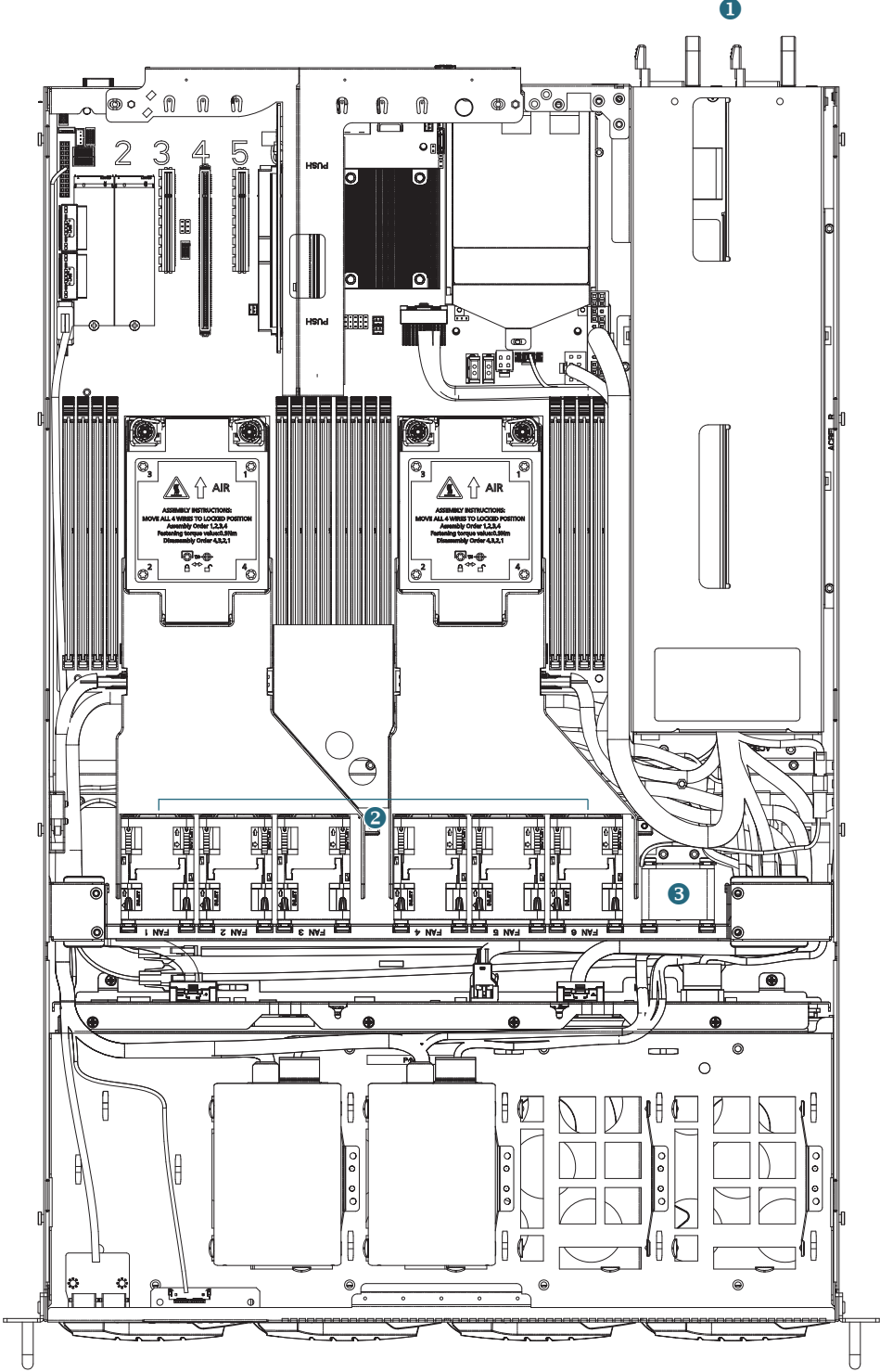

Item	Description
1	750W/1100W 1+1 redundant power supply 80+Platinum
2	6 x 40x56mm easy swap fans
3	1 x 40x28mm fan

Chapter 2. Hardware Setup

This chapter provides the graphic detail and basic instruction for hardware installation. Turn off the system and unplug all peripheral devices before proceeding.

2.1 Central Processing Unit

The serverboard supports dual Xeon scalable processors and Socket P4 (LGA-4189).

2.1.1 Installation

To ensure a safe and easy setup, you need to prepare before installation:

- a T30 torque screwdriver
- ESD wrist strap/mat and conductive foam pad
- Safe and stable environment



CAUTION

The pins of the processor socket are vulnerable and easily susceptible to damage if fingers or any foreign objects are pressed against them. Please keep the socket protective cover on when the processor is not installed.



CAUTION

When unpacking a processor, hold the processor only by its edges to avoid touching the contacts.

Standard Processor Assembly:

A standard processor assembly is comprised of 5 components: processor carrier, processor, bolster plate assembly, socket and back plate.

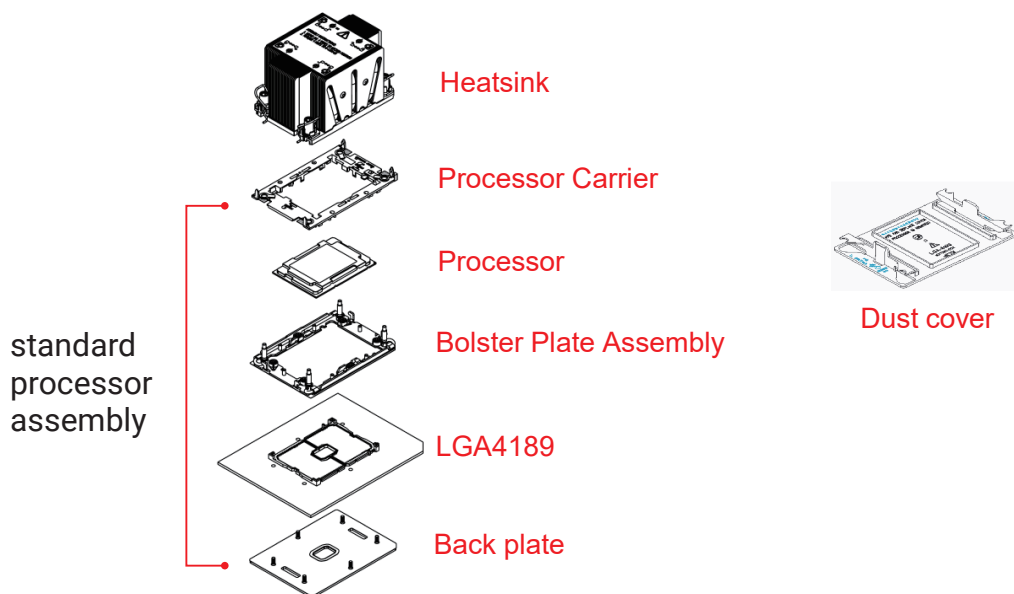

This information is provided for professional technicians only.

Procedure:

- ① Remove the dust cover. Push the tab inward on both sides to remove.

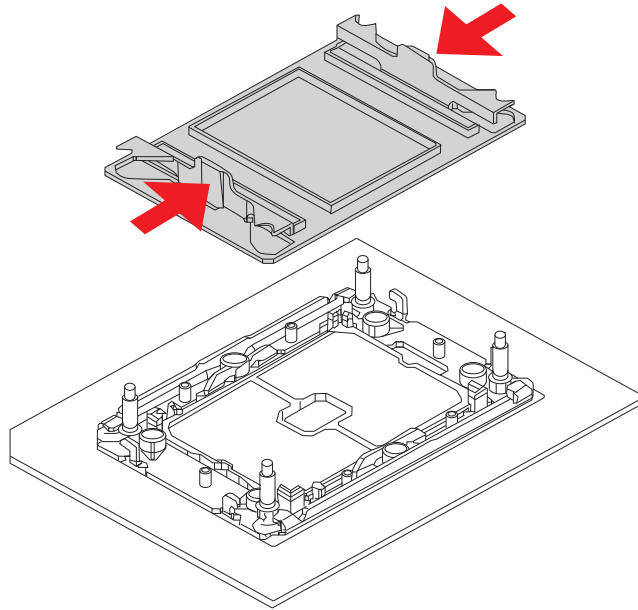

- ② Remove the Pnp cap from the socket. Press the tabs on both sides to remove.

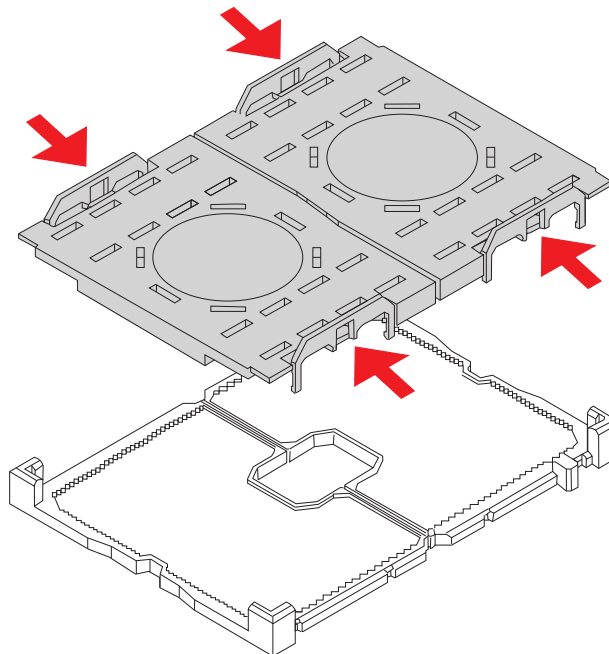

- Insert the CPU into the CPU carrier. Carefully align and insert on side of the CPU and then the other.



NOTE

Must ensure to match the direction and pin of the CPU with the carrier. Refer to the placement of pin 1.

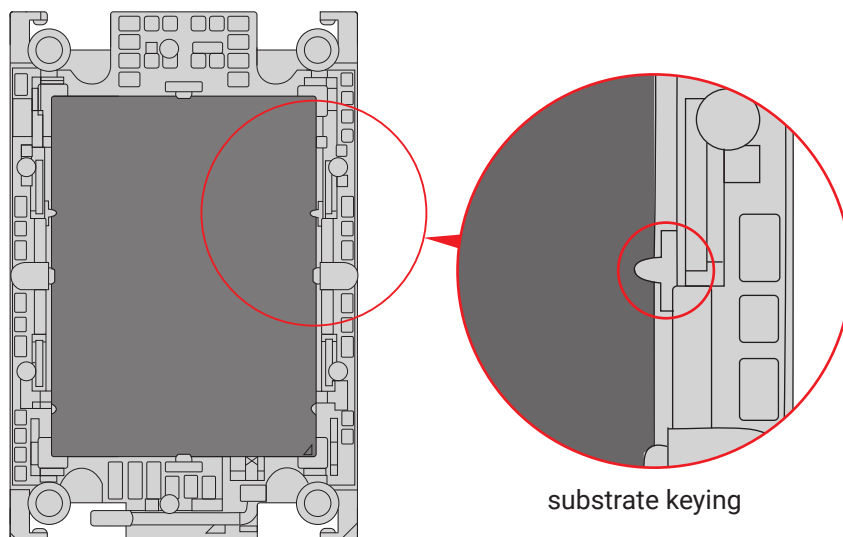
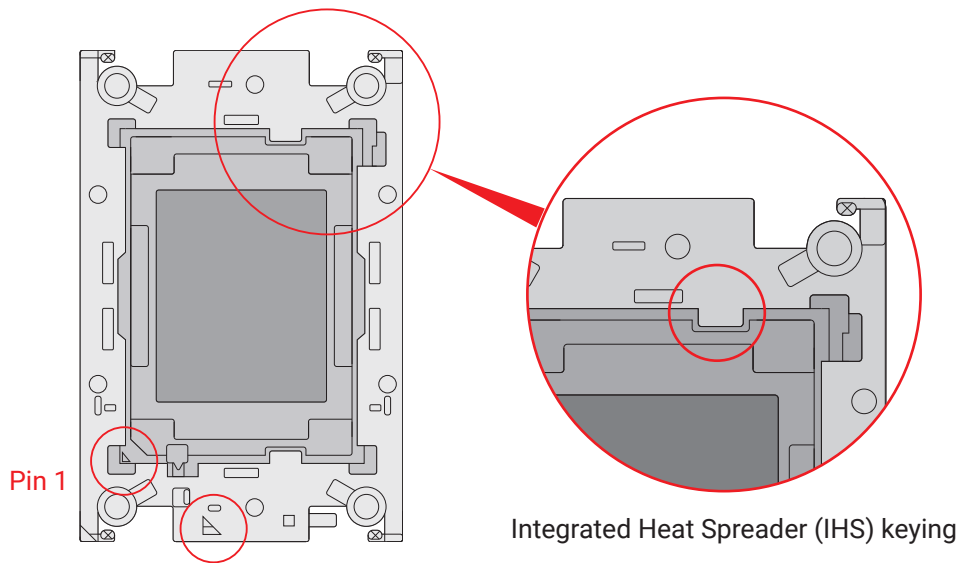

- ④ Attach the heat sink onto the CPU carrier. Hook the corners of the CPU carrier to the back side of the heat sink.

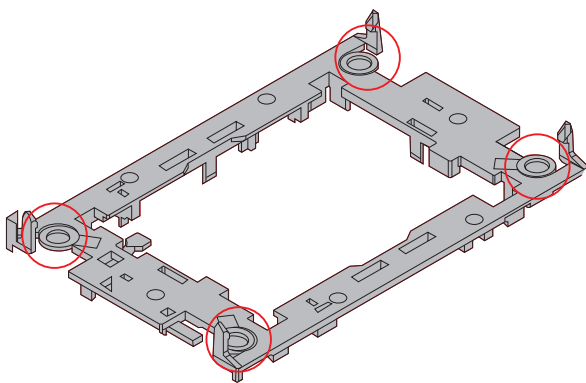

CPU carrier

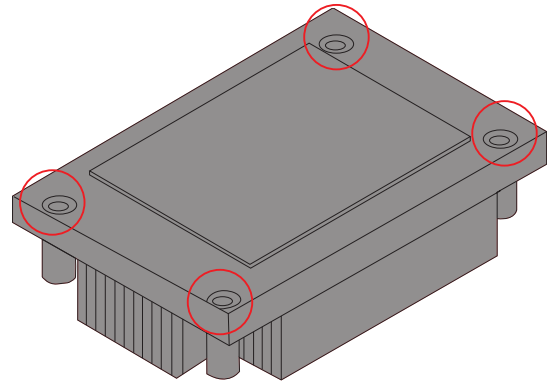

Heat sink back side

- ⑤ Install the assembled heat sink and CPU carrier onto the CPU socket. Please use a T-30 torque driver to tighten the nuts in the four corners of the heat sink labeled in the order 1 → 2 → 3 → 4.



CAUTION

Failure to tighten the heat sink screws in the specified order may cause damage to the processor socket assembly. Heat sink screws are recommended to be tightened to 8 in-lbs torque, but can be tightened to 12 in-lbs torque according to the indicated order on the top of the heatsink label.

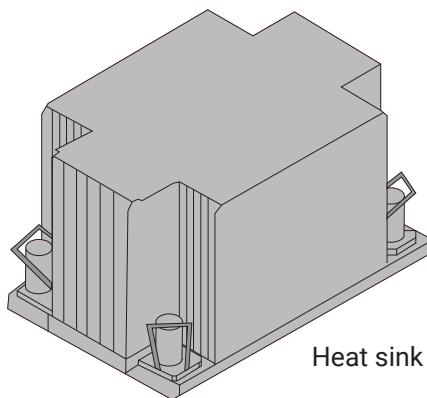

Heat sink with carrier

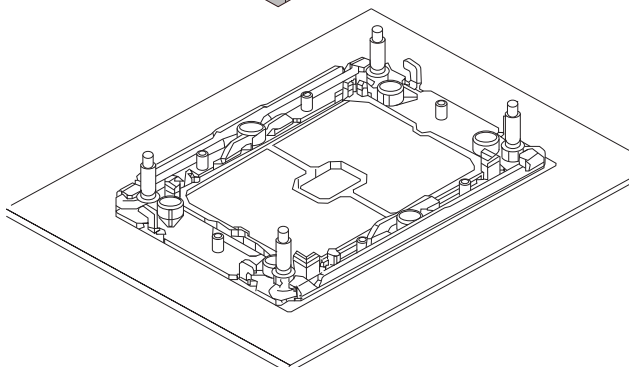

CPU socket

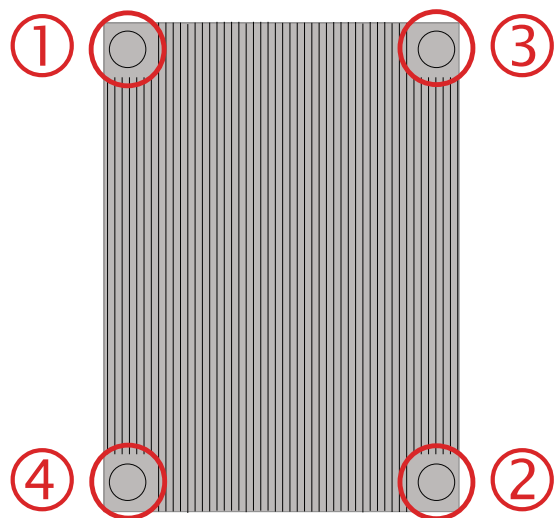

Screw tightening order

- ⑥ Press the rotating wire located on the four corners of the heat sink to latch position to secure the heat sink.

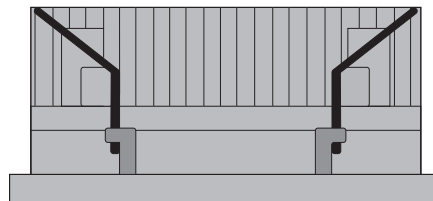
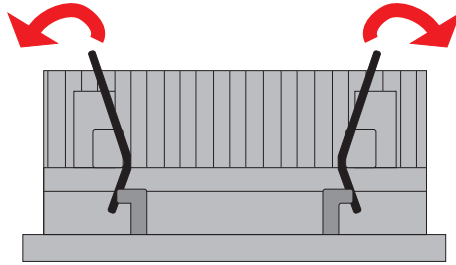

Latched position



This information is provided for professional technicians only.

2.2 System Memory

2.2.1 Placement

The DIMMs are displayed on the Tucana board as JDIMM1/JDIMM2/JDIMM3/JDIMM4/JDIMM5/JDIMM6/JDIMM7/JDIMM8/JDIMM9/JDIMM10/JDIMM11/JDIMM12/JDIMM13/JDIMM14/JDIMM15/JDIMM16

To ensure satisfactory performance, you need to:

- Verify the DIMM type:
 - This product supports DDR4 RDIMM/LRDIMM
- Verify if all of the DIMMs installed are of the same DIMM type to avoid memory failure and loss of performance speed.

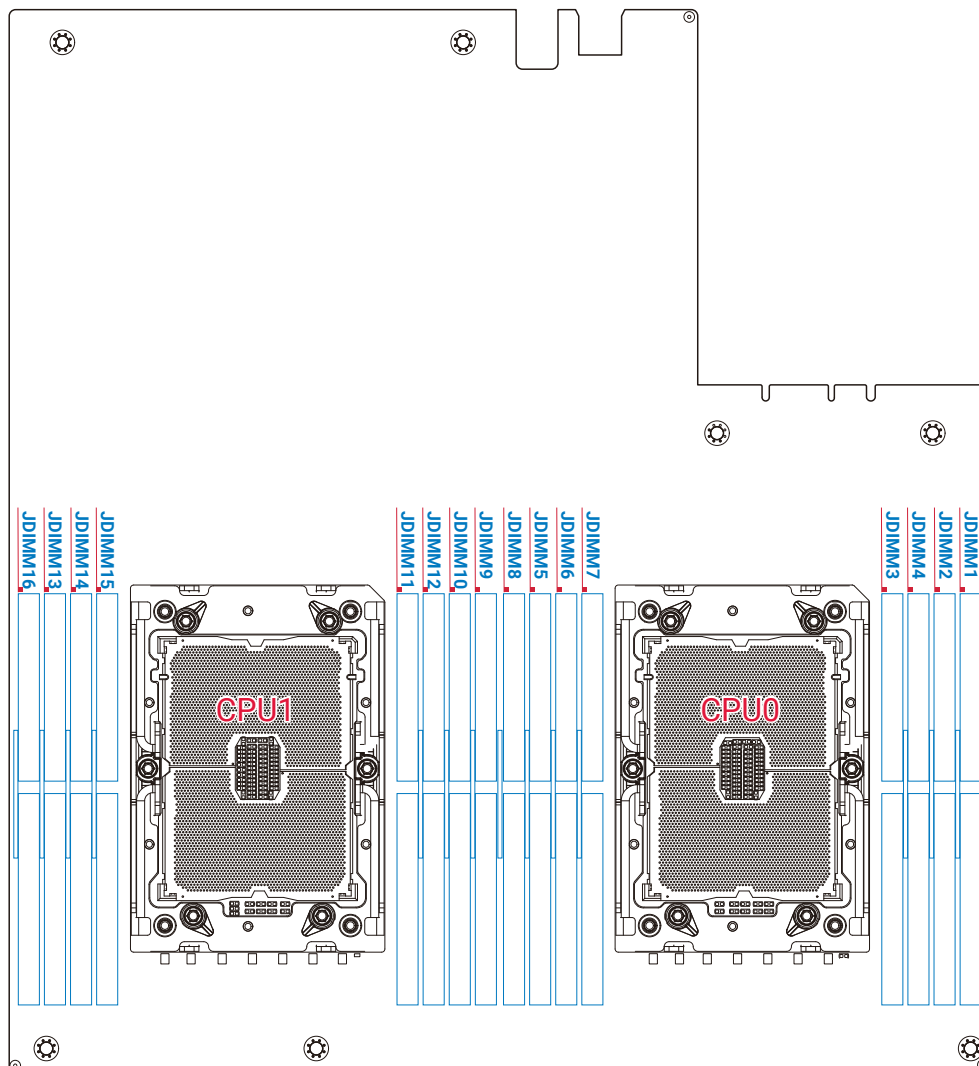

2.2.2 DIMM Population



NOTE

Rules to abide by before installation:

- Must install at least one DDR4 DIMM per socket.
- If only one DIMM is populated in a channel, you must install it in the slot furthest away from the CPU.
- Must populate DIMM0 before DIMM1.



The symbol # in the graph below indicates that the DIMM slot is populated.

1 CPU Configuration

Placement		DIMM Number				
		1	2	4	6	8
CPU0	JDIMM1		#	#	#	#
	JDIMM2	#			#	#
	JDIMM4				#	#
	JDIMM3			#		#
	JDIMM7			#		#
	JDIMM6				#	#
	JDIMM5		#	#	#	#
	JDIMM8				#	#

2 CPU Configurations

Placement		DIMM Number				
		1	2	4	6	8
CPU0	JDIMM1		#	#	#	#
	JDIMM2	#			#	#
	JDIMM4				#	#
	JDIMM3			#		#
	JDIMM7			#		#
	JDIMM6				#	#
	JDIMM5		#	#	#	#
	JDIMM8				#	#
Placement		1	2	4	6	8
CPU1	JDIMM9		#	#	#	#
	JDIMM10	#			#	#
	JDIMM12				#	#
	JDIMM11			#		#
	JDIMM15			#		#
	JDIMM14				#	#
	JDIMM13		#	#	#	#
	JDIMM16				#	#

2.2.3 Installation

Step 1 Unlock the DIMM socket by pressing the retaining clip outward.



Step 2 Insert the memory module into the slot. Make sure that the DIMM notch is accurately positioned.

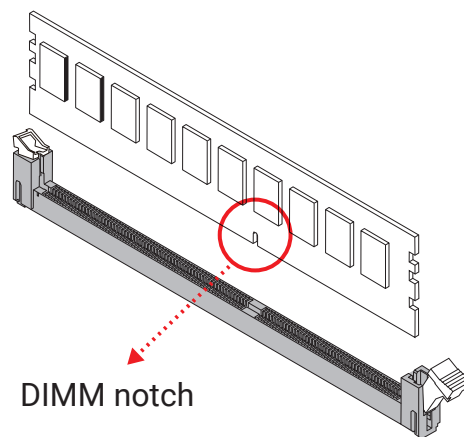

Step 3 Close the retaining clip to complete installation.

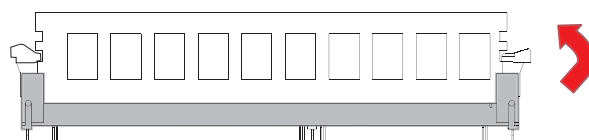

2.3 Top Cover

- ① Loosen the captive screws on the chassis.
- ② Push the top cover towards the rear panel.
- ③ Lift the top cover upward to remove.

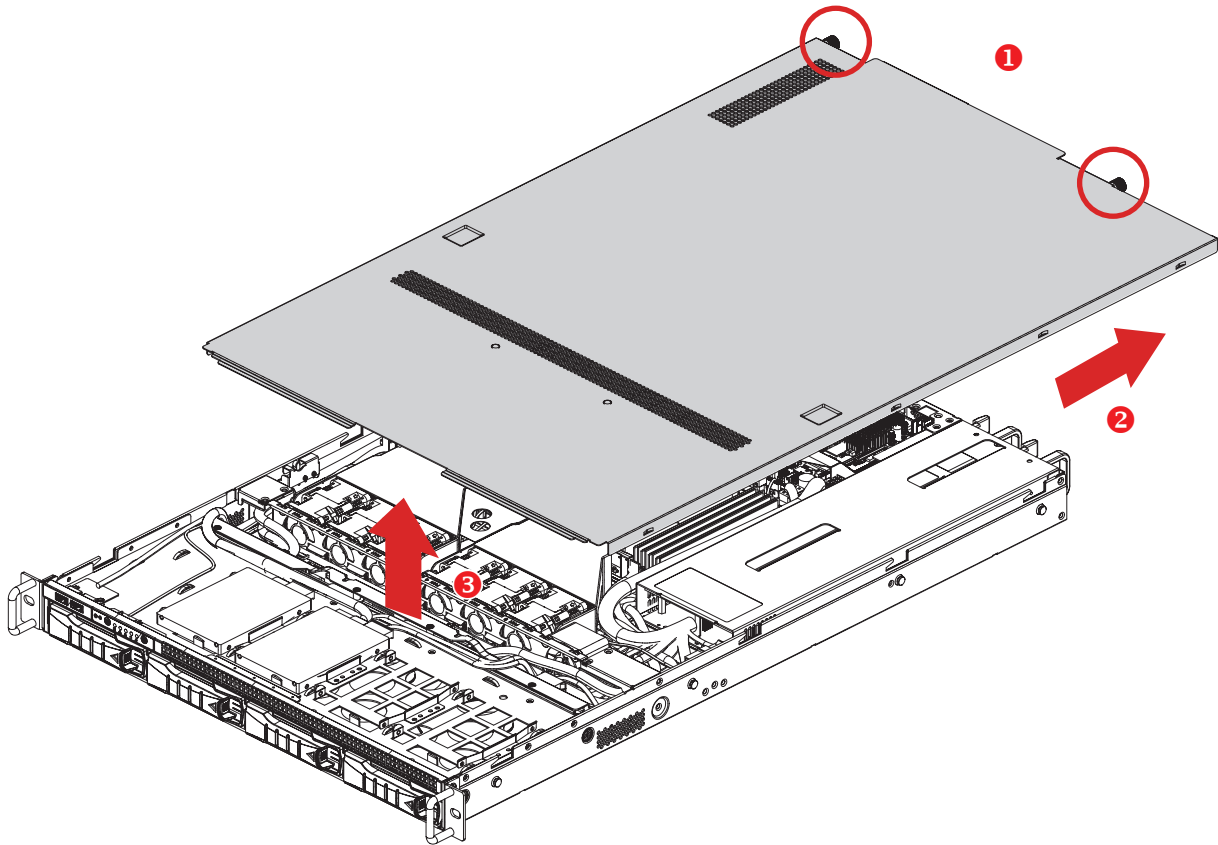

This information is provided for professional technicians only.

2.4 Power Supply Unit

2.4.1 Installation

- ① Press the ejector to release the module.
- ② Pull the handle to remove the module out of the chassis.
- ③ Push the replaced power supply unit into the chassis. Ensure that the module is hooked into the cage.

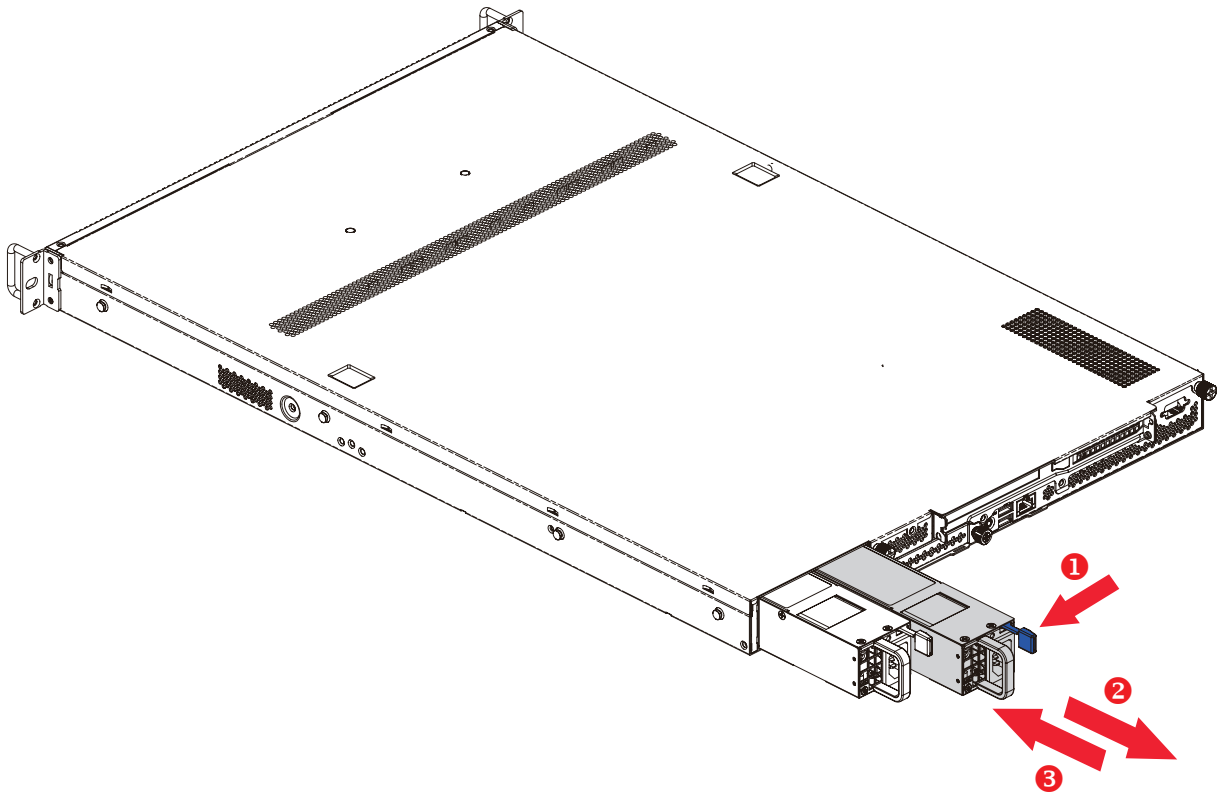

2.4.2 LED Indicator

Color	Behavior	Description
Green	Solid	Output on and working normally.
	Blinking, 1Hz	Only 5Vsb (PS off) or PSU is in cold redundant state.
Amber	Solid	Power supply critical event causing a shutdown; AC cord unplugged or AC power lost, failure, OCP, OVP, fan fail.
	Blinking, 1Hz	Power supply warning events where the power supply continues to operate high temp, high power, high current, slow fan.



This information is provided for professional technicians only.

2.5 Fan

- ① Remove the top cover from the chassis. Please refer to [Section 2.4 Top Cover](#).
- ② Unplug the fan cables and connectors from the server board.
- ③ Pull the top fan out of the chassis.

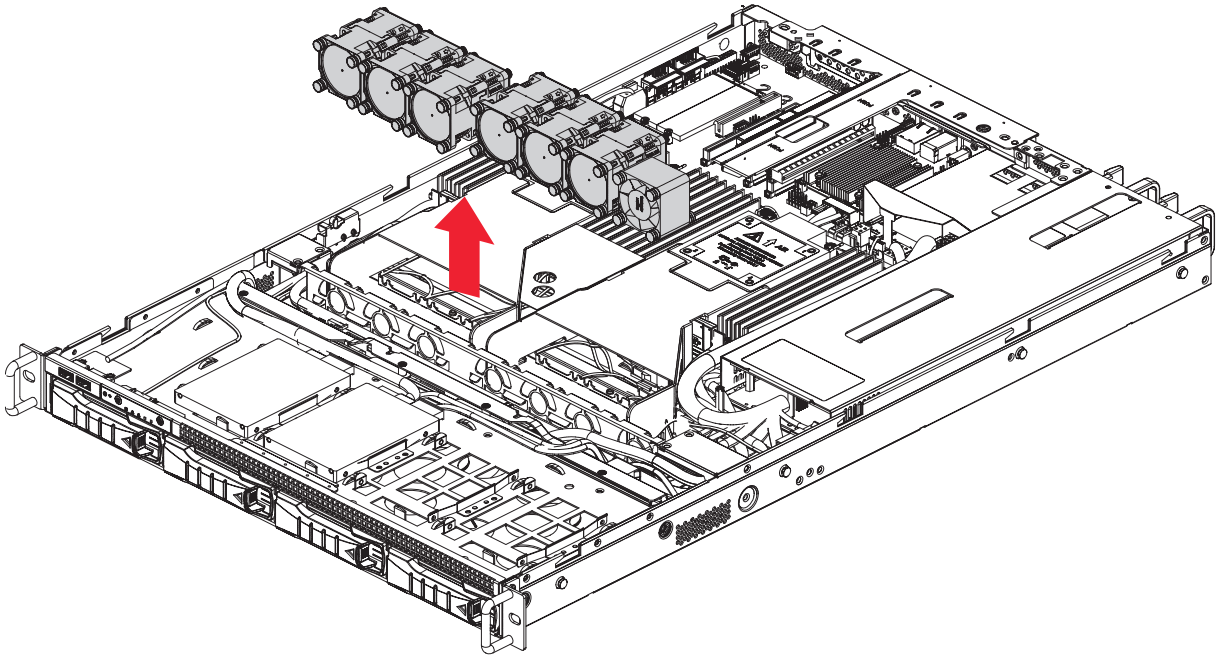

This information is provided for professional technicians only.

2.6 Disk Drive

2.6.1 Disk Drive: 2.5-inch (NVMe/SATA)

- ① Press the ejector on the tray to release the handle.
- ② Pull the tray handle completely outward.
- ③ Pull the drive tray out of the chassis.

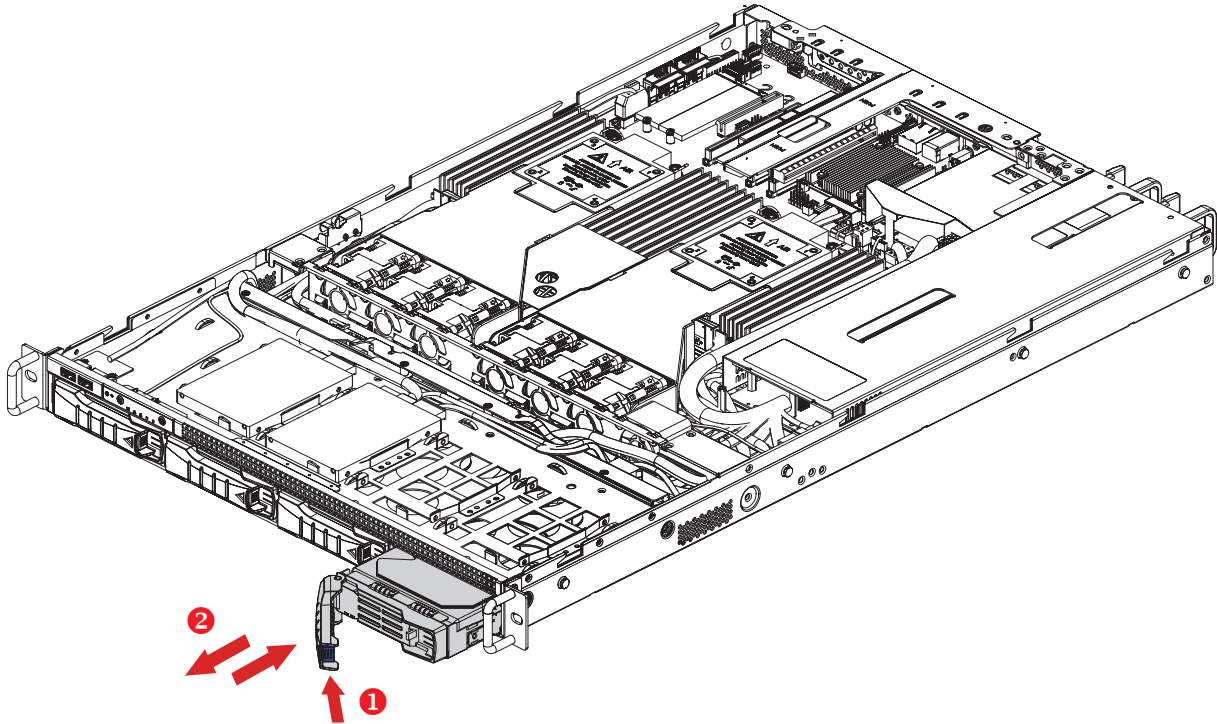

- ④ Insert the disk drive into the tray. Ensure that the dimples on the tray match the disk drive. For additional assurance, fasten the screws * 4 on the tray to secure the disk drive.

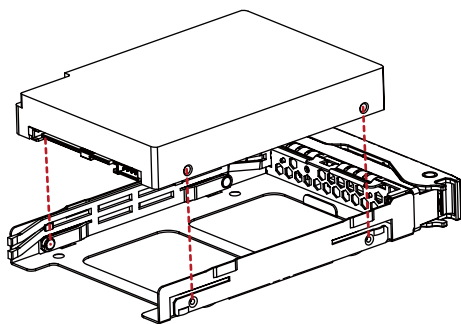

dimple placement

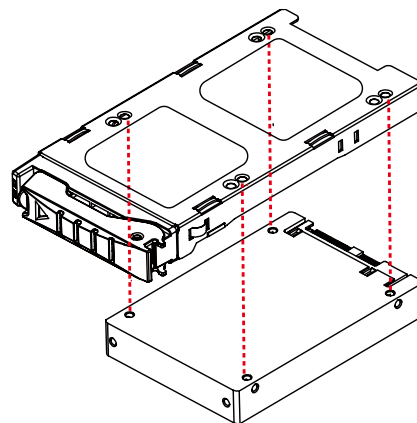

screw placement

- ⑤ Push the tray with the installed disk drive into the end of the drive slot in the chassis.
- ⑥ Close the tray handle.

2.6.2 LED Indicator

Indicator	Color	Behavior	Description
HDD Activity	Blue	On	HDD is present.
		Blinking	HDD Activity is detected.
	---	Off	HDD is not connected or the system power is off.
HDD Fault/Status LEDs	Red	On	HDD fault occurred or HDD is located.
		Blinking	HDD Rebuilt status.
	---	Off	Normal

2.6.3 Drive Slot Map

Front Panel

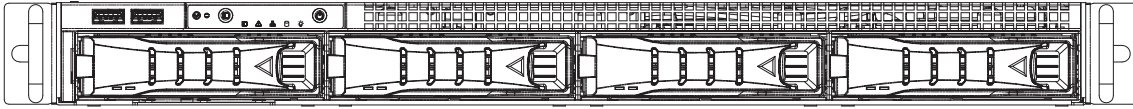

Option 1			
SATA	SATA	SATA	SATA

Option 2			
SATA/NVMe	SATA/NVMe	SATA/NVMe	SATA/NVMe

2.7 M.2 SSD (NGFF) Card

- ① Remove the top cover from the chassis. Please refer to [Section 2.3 Top Cover](#).
- ② Align and insert the M.2 card into the socket. Ensure the size of your M.2 card match the corresponding standoff on the serverboard.
- ③ Fasten the screws to complete setup.

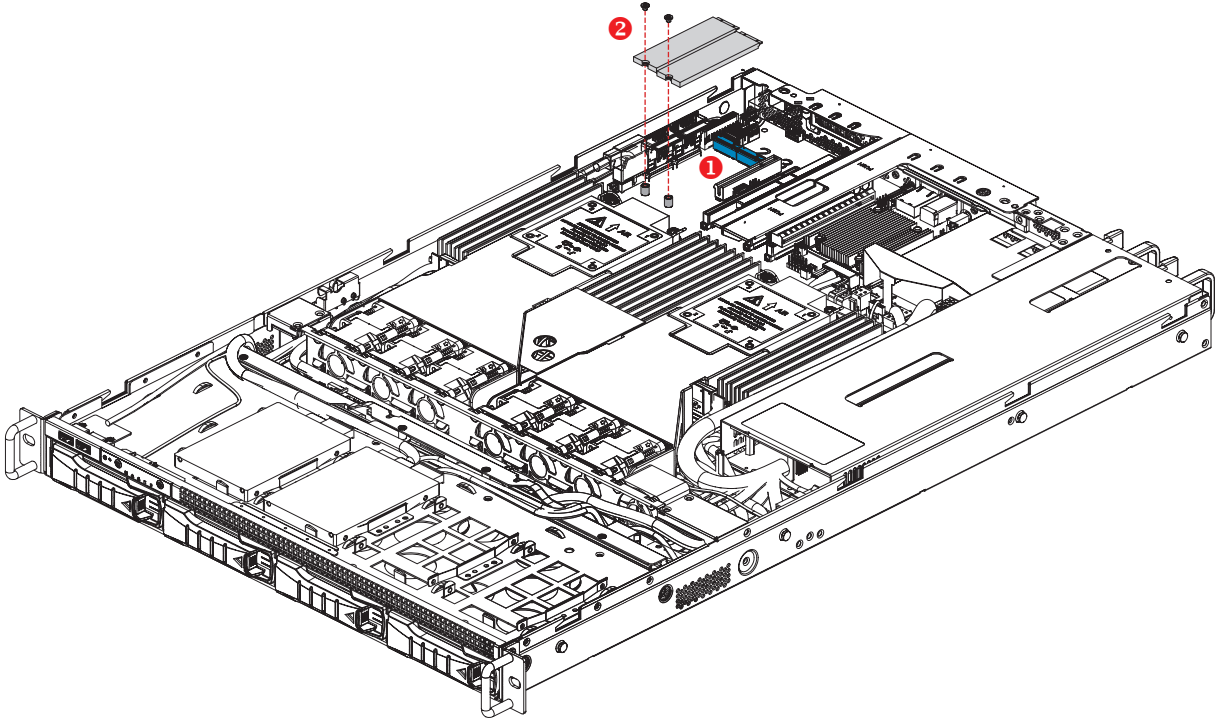

2.8 Riser Card

- ① Remove the top cover from the chassis. Please refer to [Section 2.3 Top Cover](#).
- ② Pull the riser card bracket upward to remove.
- ③ Push the replaced riser card into the appropriate card slot. Ensure that the card is properly aligned.

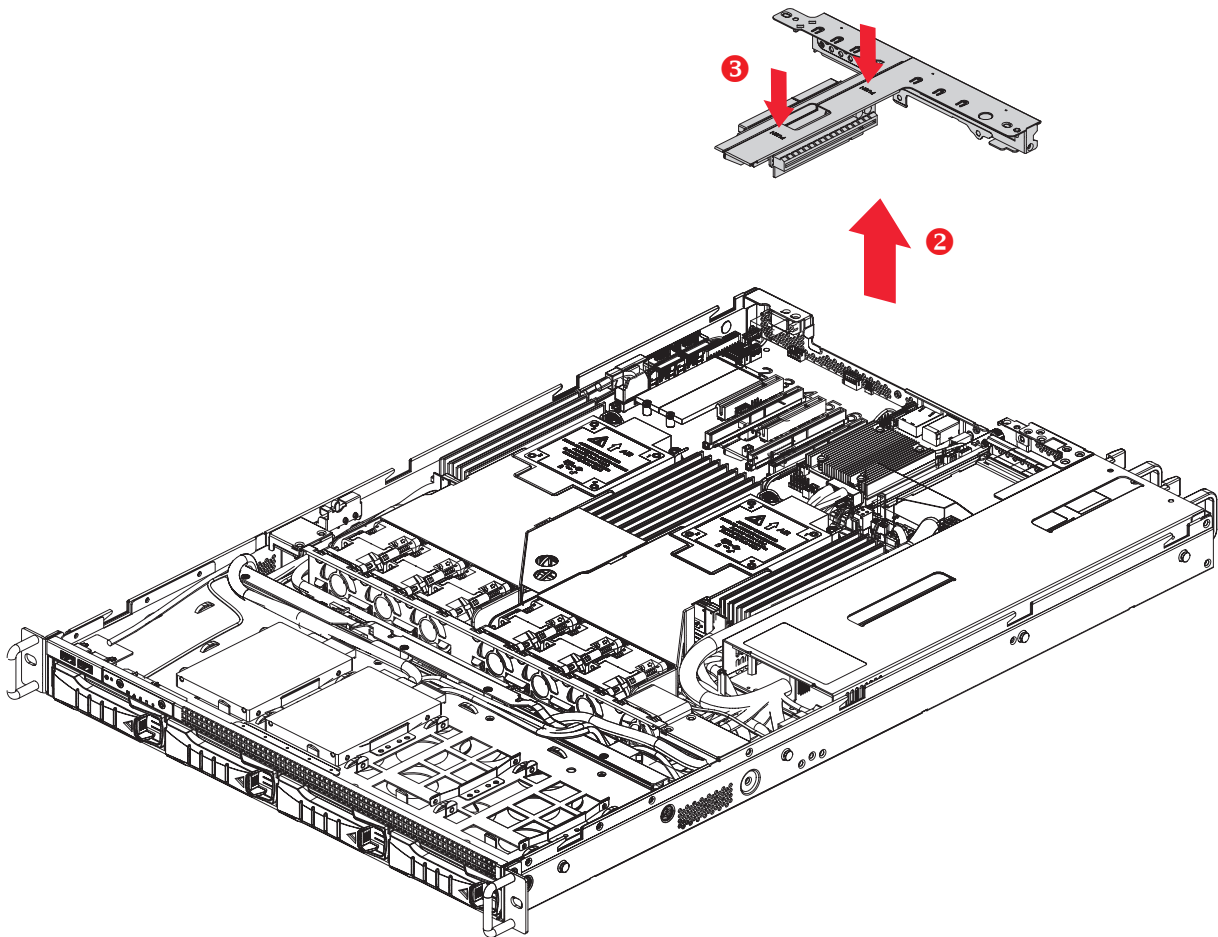

2.9 Slide Rail

NOTE



This sections provides a basic instruction for mounting the slide rail onto the system. Tool-less rails vary per order. The rail in this manual may not exactly match the rail for your system. Please refer to the specifications or quick installation guide that came with your purchased product.

CAUTION



The rack may tilt and fall due to incorrect installation or placed on uneven grounds. The rack must be placed in a flat surface before you begin to slide the system barebone in for servicing.

1. Pull the inner rail out of the slide rail until it clicks.
2. Detach the inner rail completely from the slide rail by pulling the white tab forward.

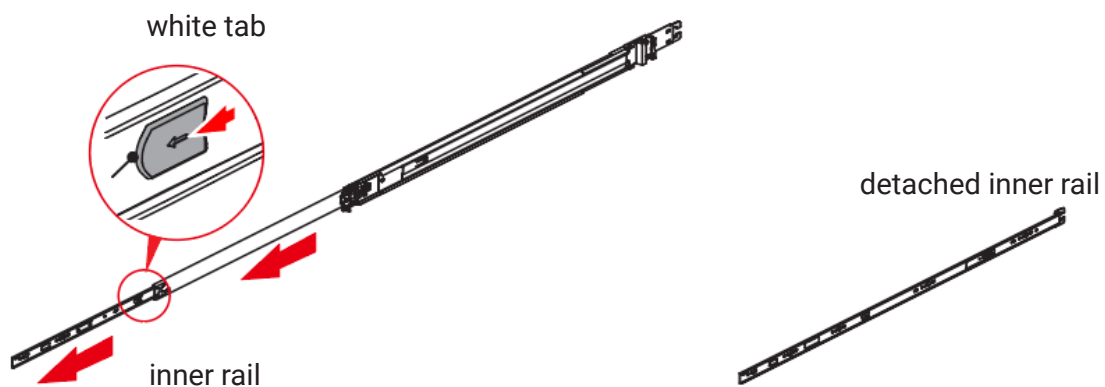

3. After the inner rail is dislodged, adjust the middle rail back to its original position by pushing the tab on the middle rail.

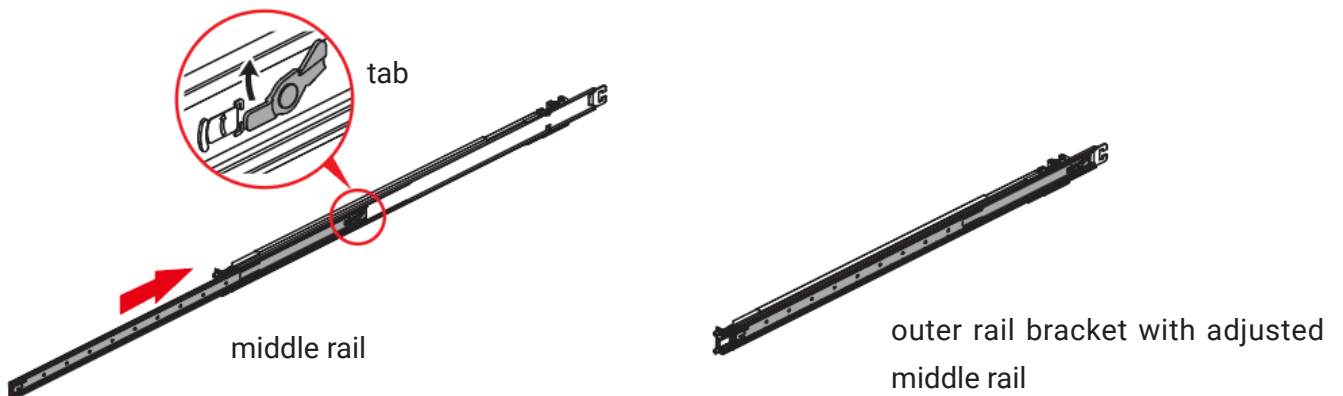

4. Install the inner rail onto the system barebone. Lock the keyholes and secure the screws on sides of the system.

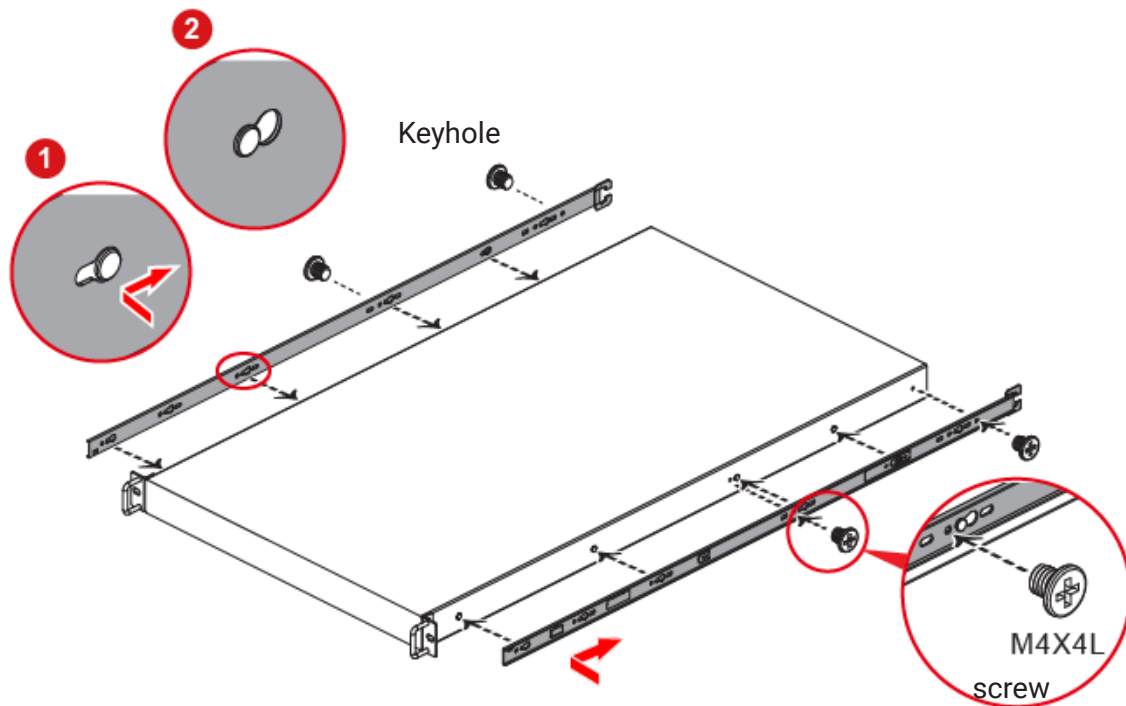

5. Continue installing the outer rail bracket to the mounting frame. Attach the outer rail assembling to the frame and press the bracket to form a rack on both ends. Repeat to fully mount the bracket assembly on the other side.

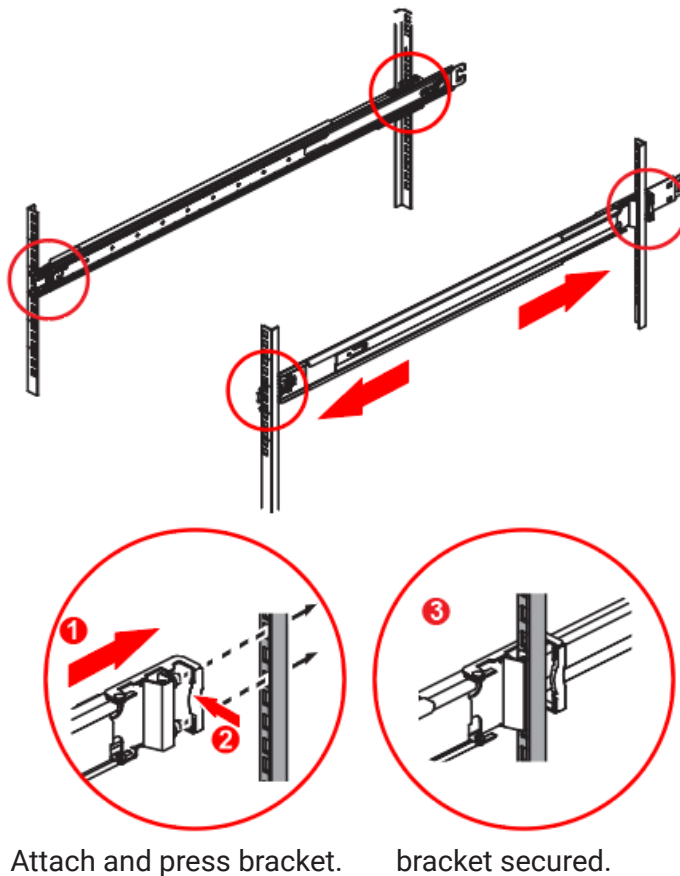

Attach and press bracket.

bracket secured.

6. Pull out the middle channel until the ball bearing retainer is locked forward.

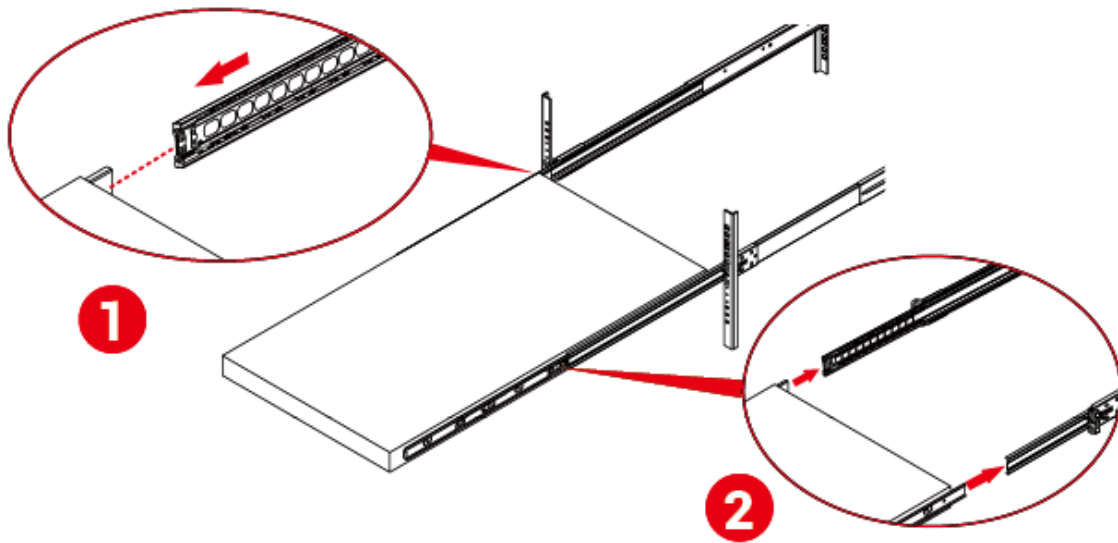
**NOTE**

Verify ball bearing retainer is locked forward.

7. Slide the release tab and push barebone into rack. Make sure the barebone is completely installed onto the rack.

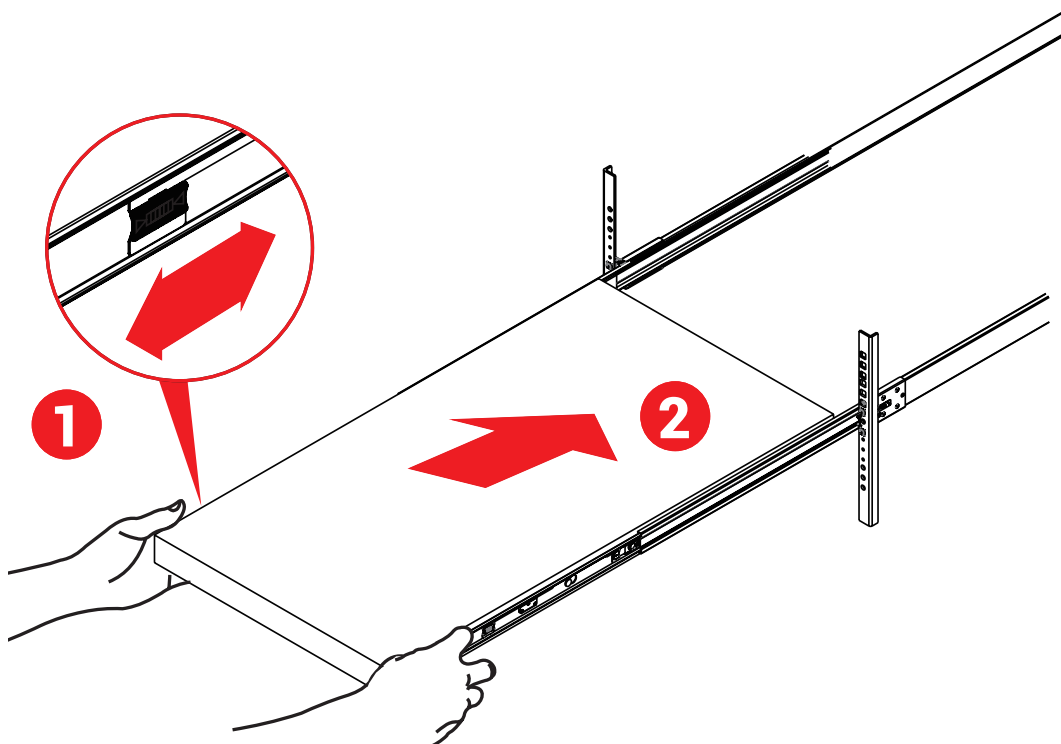

This information is provided for professional technicians only.

Chapter 3. Hardware Settings

This section provides illustrations that display the internal jumpers, connectors, and system LED indicators on the Tucana motherboard. The motherboard layout and essential connectors are listed below for your reference.

3.1 Block Diagram

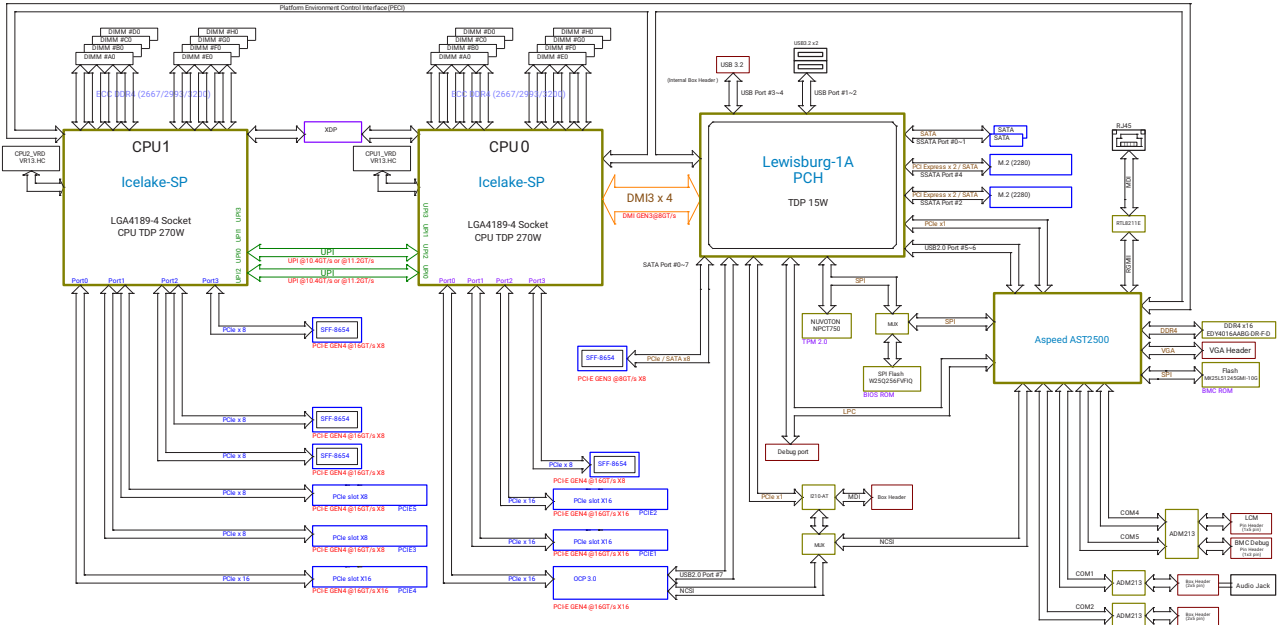

3.2 Placement

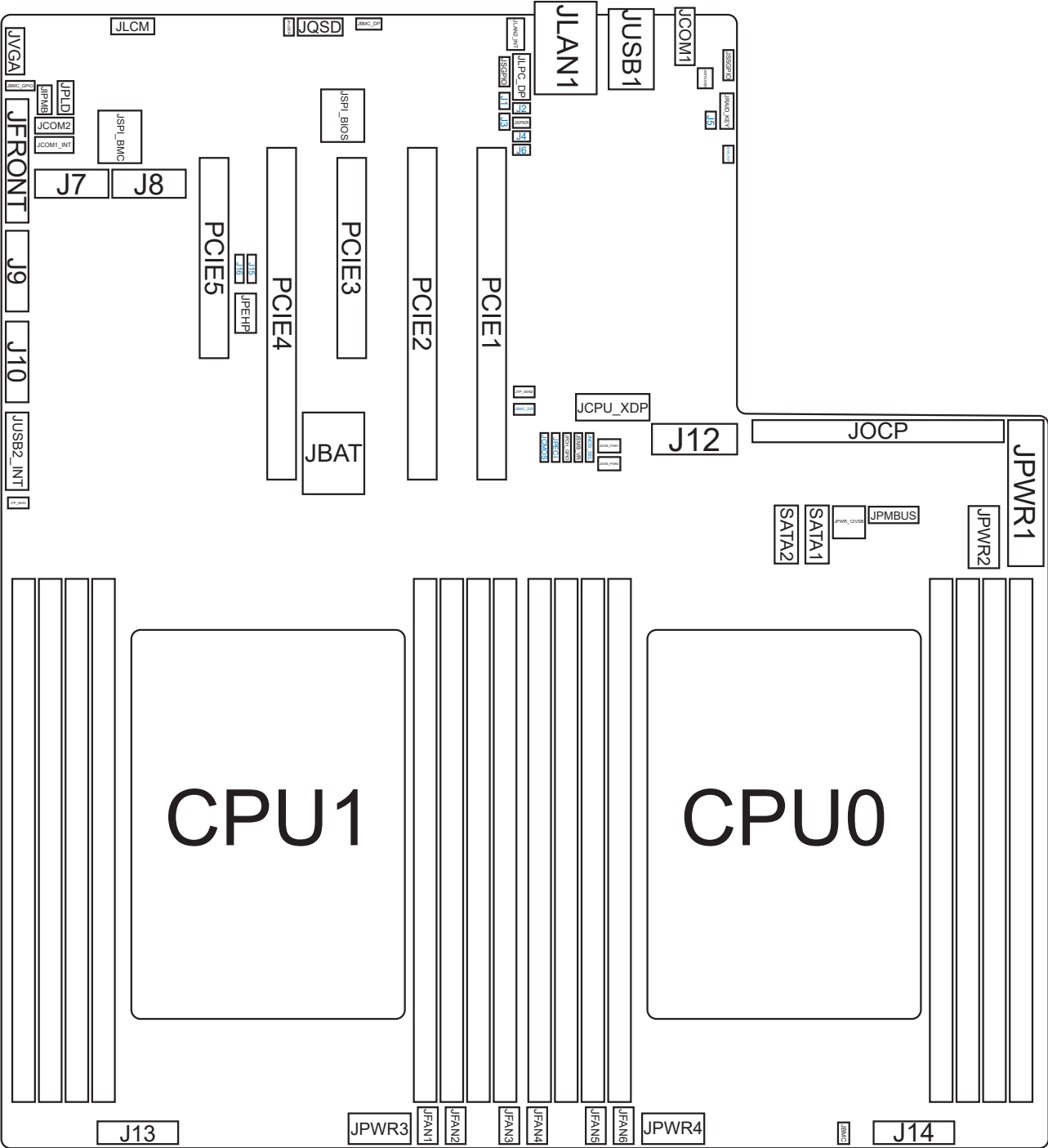

3.3 Content List

Port/Slot/Socket		Port/Slot/Socket	
RJ45 Port	JLAN1	Battery	JBAT
USB 3.0 Type A Port	JUSB1	SPI BMC Socket	JSPI_BMC
COM Port	JCOM1	COM Port Header	JCOM1_INT JCOM2
PCIE 4.0 Slot	PCIE1 PCIE2 PCIE4	VGA Connector	JVGA
PCIE 4.0 Slot	PCIE3 PCIE5	OCP 3.0 Connector	JOCP
SPI BIOS Socket	JSPI_BIOS		
Connector	Placement	Connector	Placement
LCM Header	JLCM	Power Supply Connector	JPWR1
BMC Buzzer	JBUZZER	SATA Connector	SATA1 SATA2
PLD QSD Header	JQSD	Power Supply Connector	JPWR_12VSB
BMC Debug Port Header	JBMC_DP	PMBUS Header	JPMBUS
I210 MDI Header	JLAN2_INT	Power Supply Connector	JPWR2 JPWR3 JPWR4
PCH SGPIO Header	JSSGPIO JSGPIO	BMC I2C10 Header	JBMC
Chassis Intrusion	JINTRUDER	Fan Connector	JFAN1 JFAN2 JFAN3 JFAN4 JFAN5 JFAN6
LPC Debug Port Header	JLPC_DP	Front I/O USB Header	JUSB2_INT
Speaker	JSPKR	CPU PCIe Hot Plug Header	JPEHP
VROC Key Header	JRAID_KEY	SFF-8654 Connector (PCIe 4.0)	J9 J10 J13 J14
External Thermal Sensor Header	JTP_SEN1 JTP_SEN2	Front Panel Header	JFRONT
CPU XDP Header	JCPU_XDP	M.2 (2280) Connector	J7 J8
PCH GPIO Header	JPCH_GPIO	IPMB Header	JIPMB
VRM SMB Header	JSMB_VR	PLD Download Header	JPLD
SATA DOM Power Header	JDOM_PWR1 JDOM_PWR2	BMC GPIO Header	JBMC_GPIO
SFF-8654 Connector (PCIe 3.0/SATA3)	J12		

Jumper	Placement	Jumper	Placement
J12 SSD1 PCIE/SATA Select Jumper	J15	BIOS Recovery Mode Jumper	J6
J12 SSD2 PCIE/SATA Select Jumper	J16	BMC Reset Jumper	JBMC_RST
No Reboot (Watch Dog) Jumper	J1	BMC ARM Disable Jumper	JBMC_DIS
BMC Debug Port Select Jumper	J2	CMOS Jumper	JCMOS
ME Force Recovery Mode Jumper	J3	PECI Master Select Jumper	JPECI
BMC SoC Flash Configuration Jumper	J4	BMC NCSI Select Jumper	JNCSI_SEL
Flash Descriptor Security Override Jumper	J5		

3.4 External Port

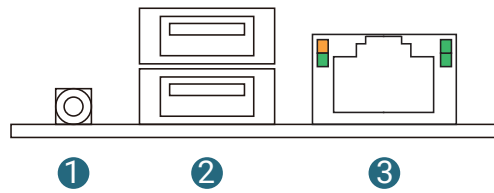

Item	
1	COM by Phone Jack
2	2 * USB 3.2 Gen1x1
3	RJ45 for BMC management

LAN LED Indicator



Item	Color	Behavior
Activity/Link LED	Green (blinking)	Activity detected.
	Off	Not active, LAN cable no connect.
	On	Link.
Speed LED	Off	10M bps connection or no link.
	Green	100M bps connection.
	Orange	1G bps connection.

3.5 Connector Definition

LCM Header (JLCM)

This is a 5-pin header that supports the LCM(LCD Module).

1	SW_PWR_BTN#
2	SW_RST_BTN#
3	TXD
4	RXD
5	GND

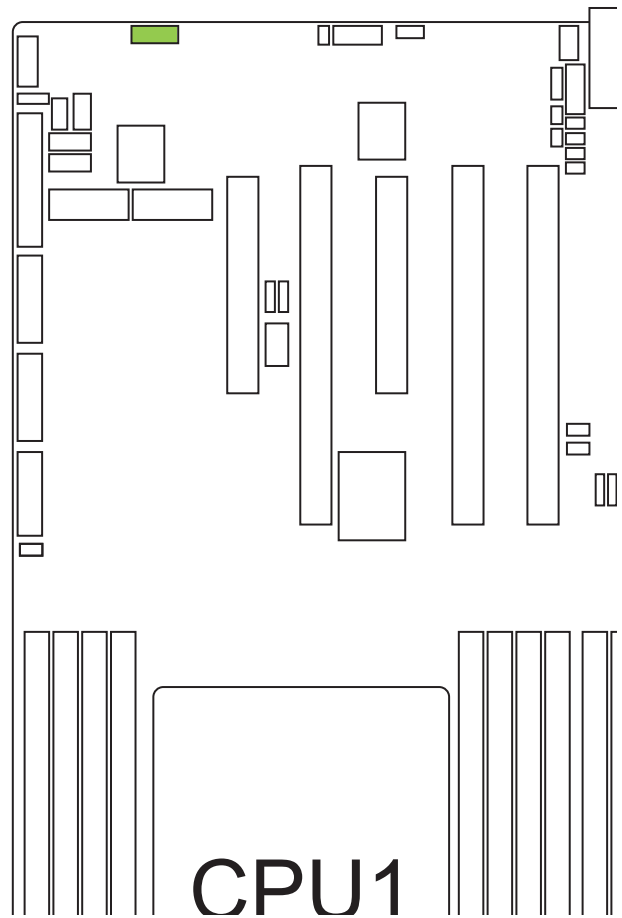
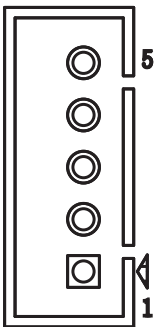

PLD QSD Header (JQSD)

This is a 2x5-pin header that supports PLD(Programmable Logical Device) debug.

+3.3V_DUAL	2	1	QSD_CLK
GND	4	3	QSD_LD#
SMB_SCL	6	5	QSD_DI
SMB_SDA	8	7	QSD_DO
MCU_PRSENT#	10	9	GND

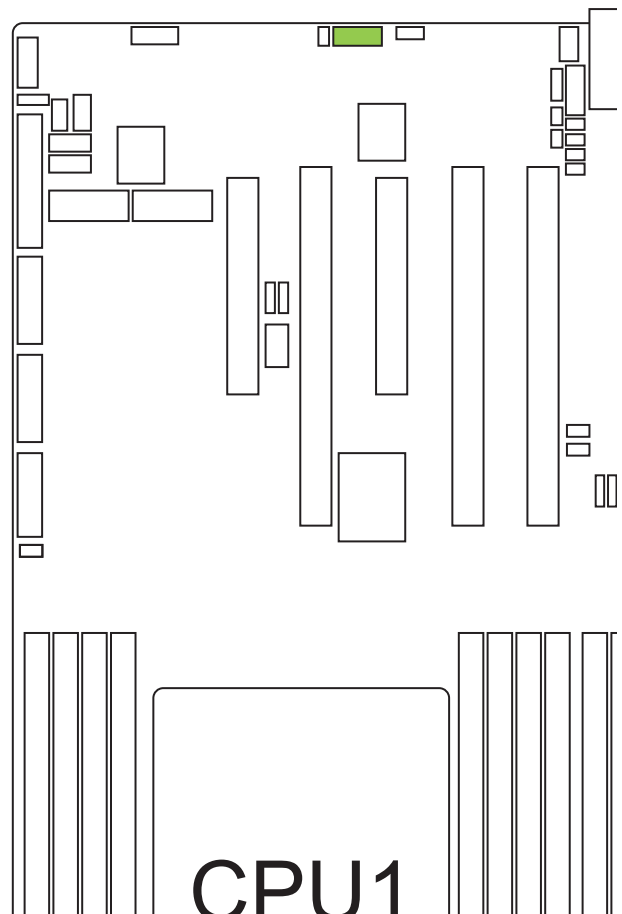
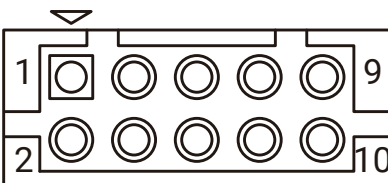

BMC Debug port Header (JBMC_DP)

This is a 3-pin connector that supports BMC debug.

1	SPE_TXD
2	SPE_RXD
3	GND

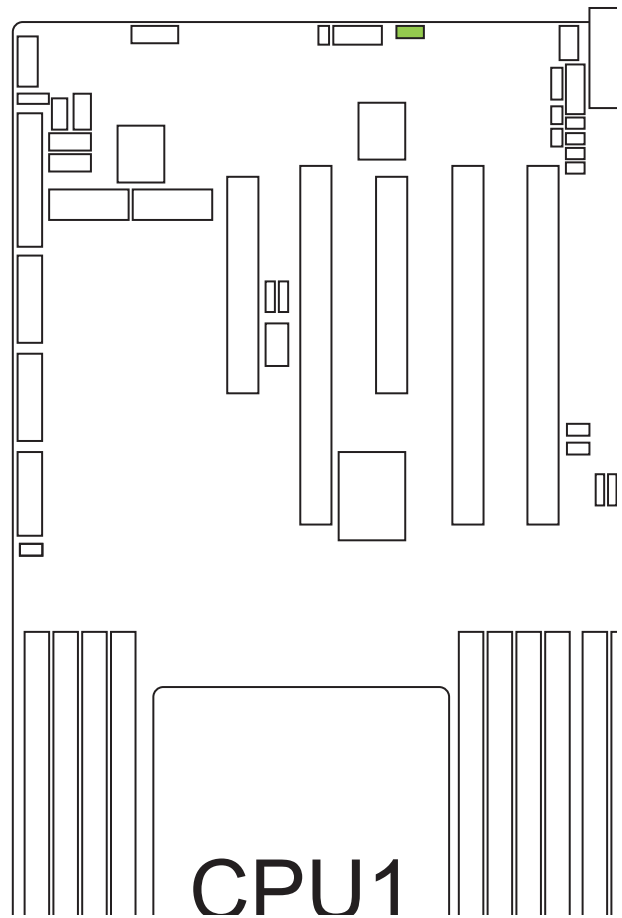
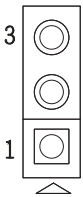

I210 MDI Header (JLAN2_INT)

This 2x4-pin header is used to provide I210 MDI(Media Dependent Interface) functionality.

MDI_DN2	2	1	MDI_DP3
MDI_DP2	4	3	MDI_DN3
MDI_DN1	6	5	MDI_DP0
MDI_DP1	8	7	MDI_DN0

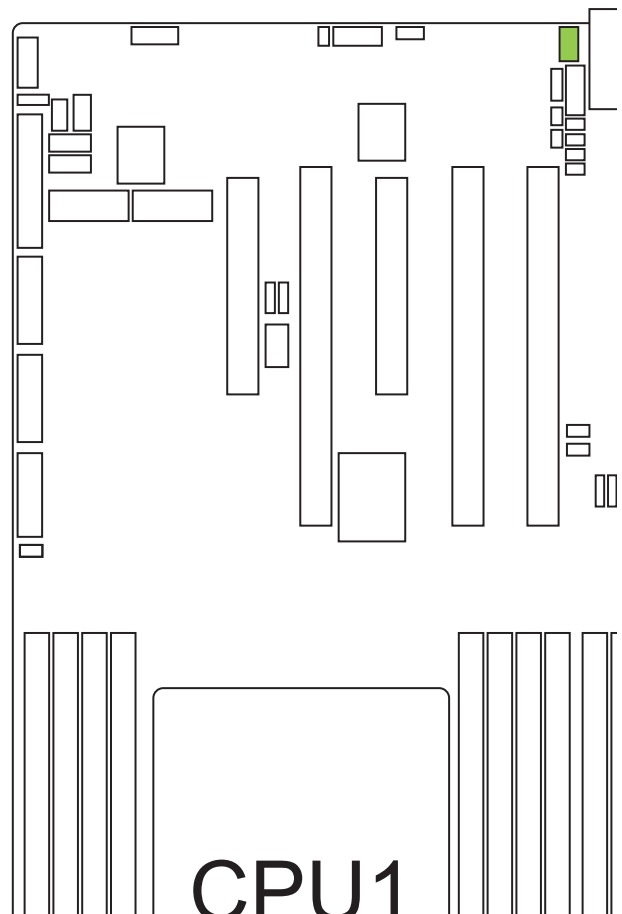
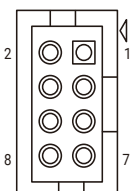

PCH SGPIO Header (JSSGPIO & JSGPIO)

This is a 6-pin connector that is used to control general device data.

1	GND
2	DATA1
3	DATA0
4	LOAD
5	CLOCK
6	+3.3V

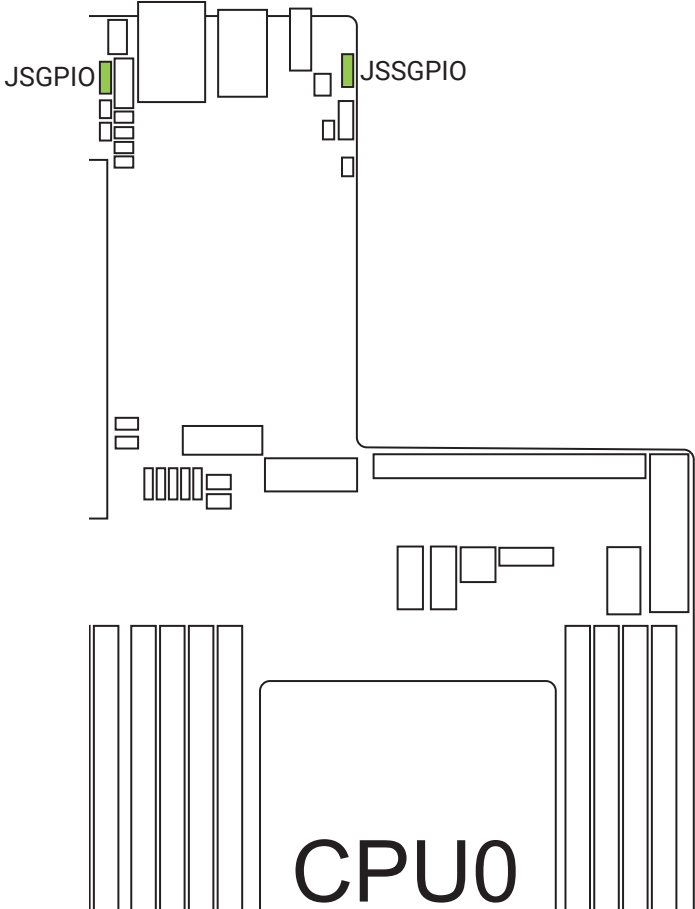
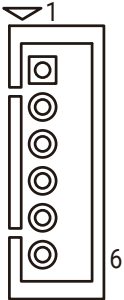

Chassis Intrusion (JINTRUDER)

This is a 2-pin connector that supports chassis security.

JINTRUDER	Setting	
Short	Case open	
Open	Enable	Default

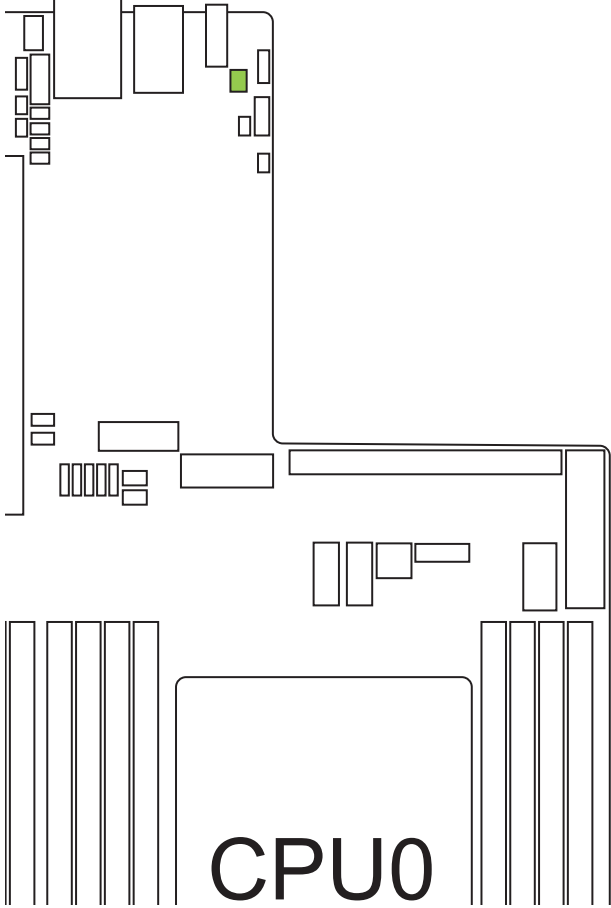
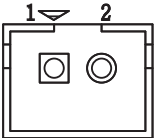

LPC Debug Port Header (JLPC_DP)

This is a 2x6-pin header for low pin count debug.

CLK_24M	2	1	GND
LFRAME_N	4	3	PIRQA
PLTRST_N	6	5	SERIRQ
LAD3	8	7	LAD2
+3.3V	10	9	LAD1
LAD0	12	11	GND

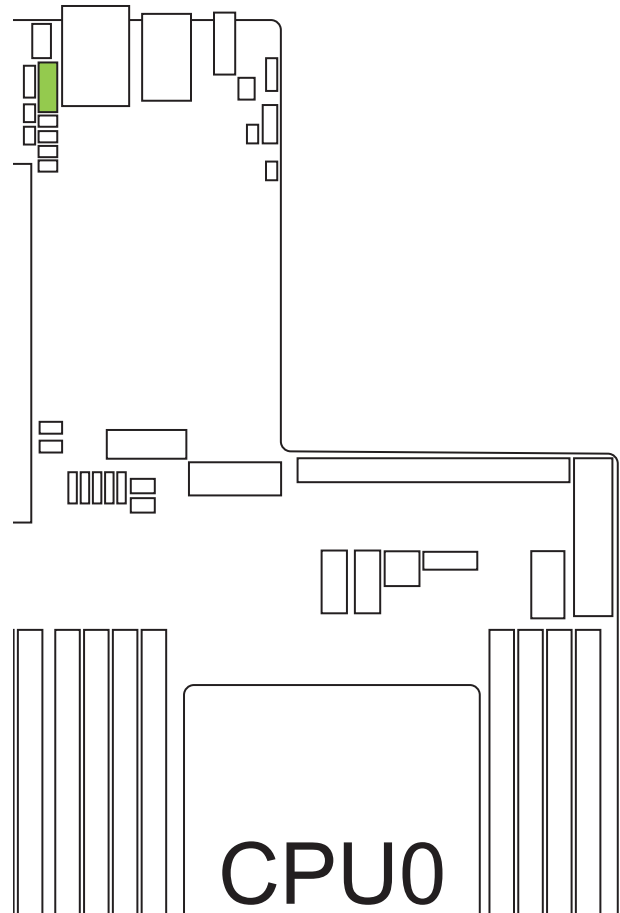
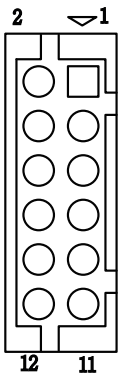

VROC Key Header (JRAID_KEY)

This is a 4-pin key that supports VROC (Intel® Virtual RAID on CPU), specifically used for NVMe SSDs.

1	GND
2	+3.3V_DUAL
3	GND
4	PCH_GPP_C10

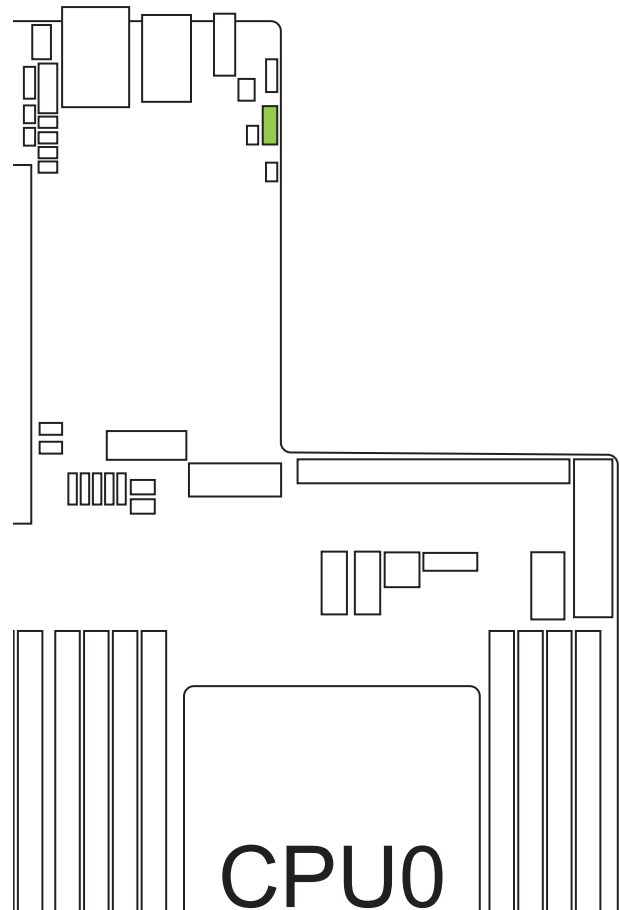
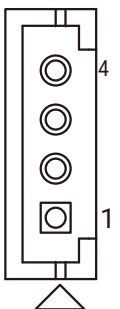

PCH GPIO Header (JPCH_GPIO)

This is a 3-pin header defines an input and output signal to the platform controller hub.

1	PCH_GPP_C16
2	PCH_GPP_C17
3	GND

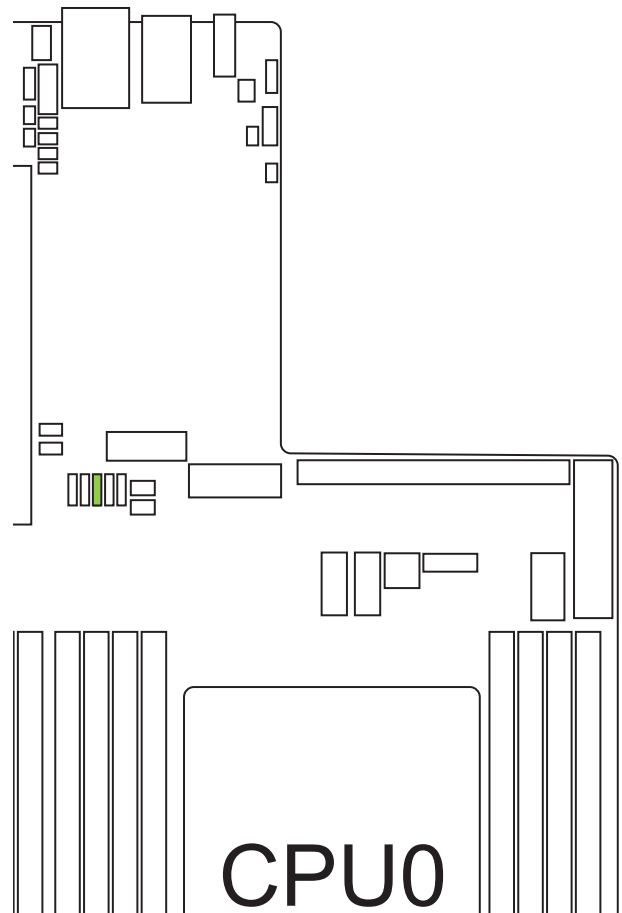
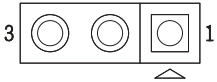

VRM SMB Header (JSMB_VR)

This is a 3-pin SMBus header that supports VRM (Voltage Regulator Module).

1	SMB_VR_DAT
2	GND
3	SMB_VR_CLK

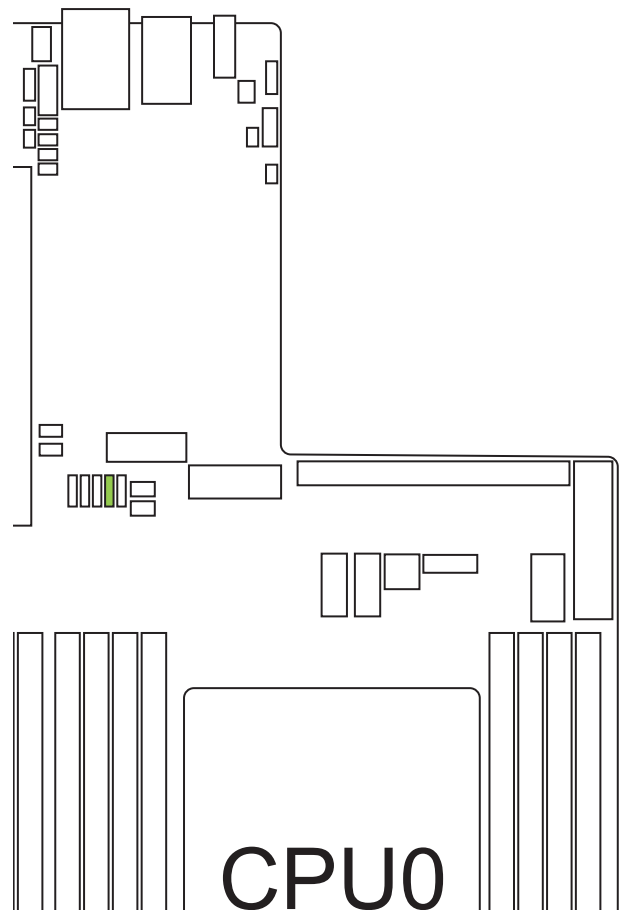
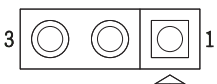

SATA DOM Power Header

(JDOM_PWR1 & JDOM_PWR2)

This is a 2-pin header that supplies power to SATA DOM.

1	GND
2	+5V

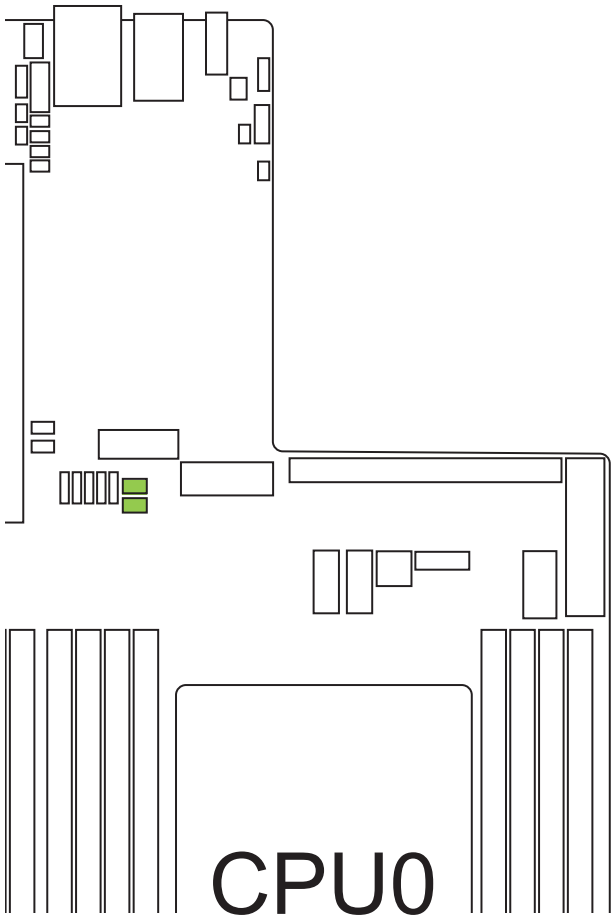
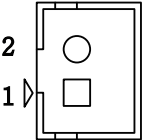

Power Supply Connector (2x10-pin) (JPWR1)

This is a 2x10-pin connector that provides the motherboard with power.

+3.3V	11	1	+3.3V
N.C.	12	2	+3.3V
GND	13	3	GND
PSON	14	4	+5V
GND	15	5	GND
GND	16	6	+5V
GND	17	7	GND
N.C.	18	8	PWR0K
+5V	19	9	+5VSB
+5V	20	10	+12V

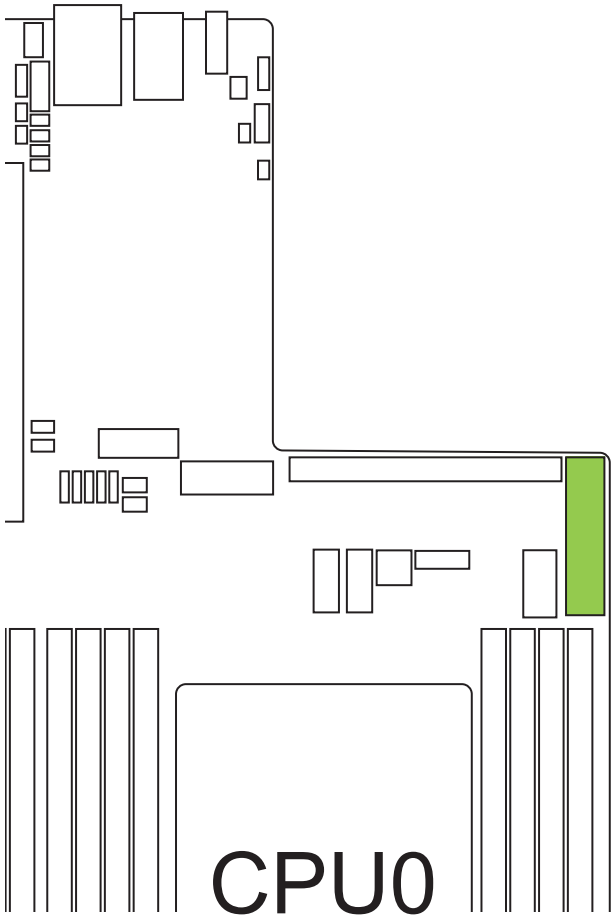
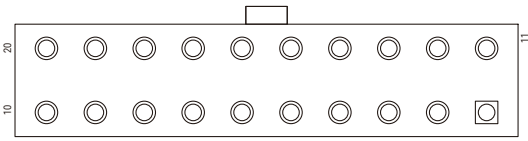

Power Supply Connector (2x2-pin)

(JPWR_12VSB) (option)

This is a 2x2-pin connector that provides the motherboard with power.

+12VSB	3	1	GND
+12VSB	4	2	GND

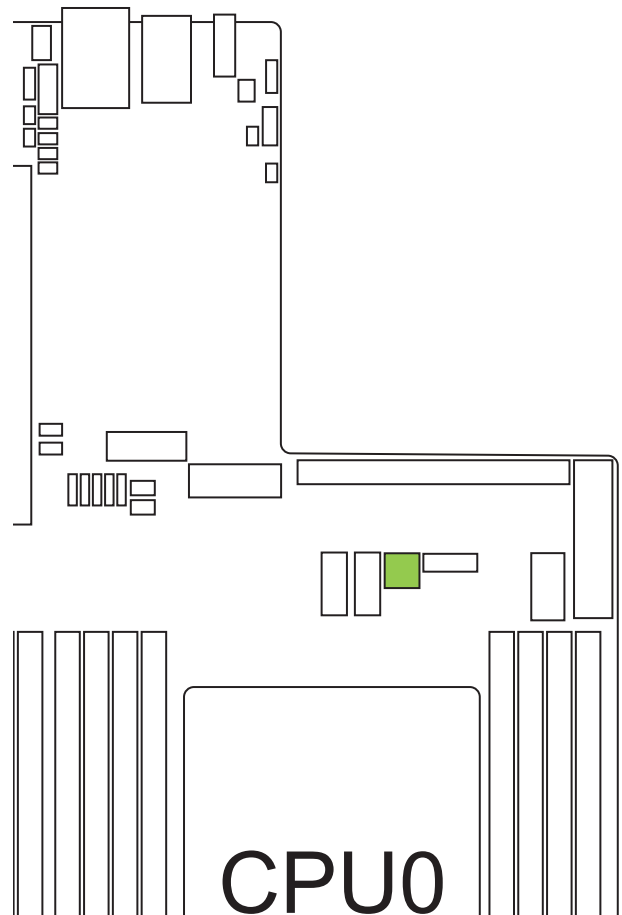
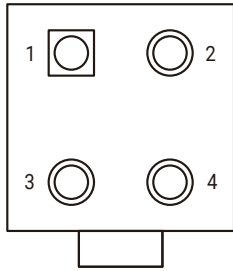

PMBUS Header (JPMBUS)

This is a 5-pin header that is used to control power supplies.

1	SMB_PMBUS_CLK
2	SMB_PMBUS_DATA
3	PMBUS_ALERT_N
4	GND
5	5VSB

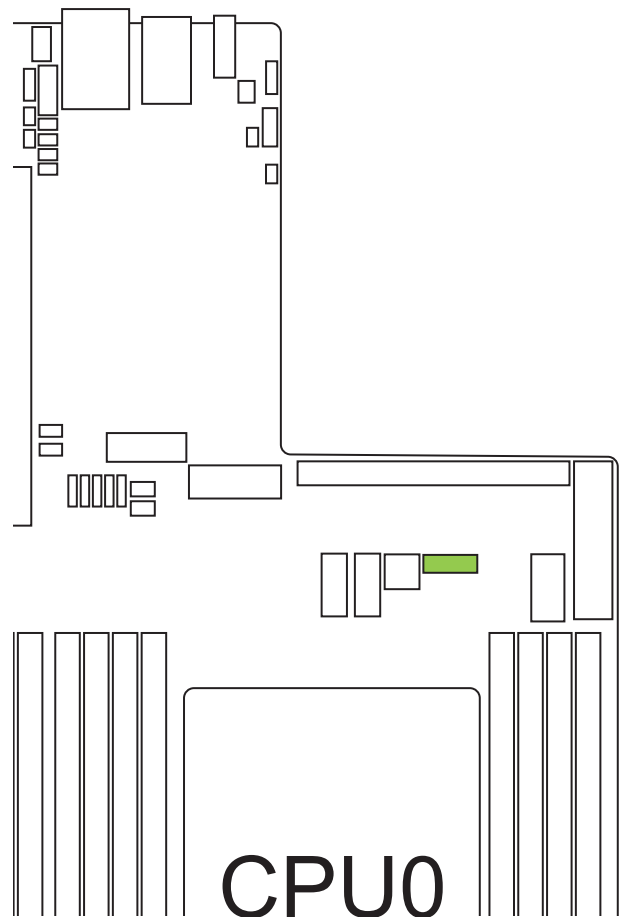
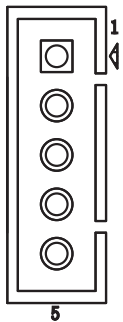

Power Supply Connector (2x4-pin)
(JPWR2, JPWR3 & JPWR4)

This is a 2x4-pin connector that provides the motherboard with power.

+12V	5	1	GND
+12V	6	2	GND
+12V	7	3	GND
+12V	8	4	GND

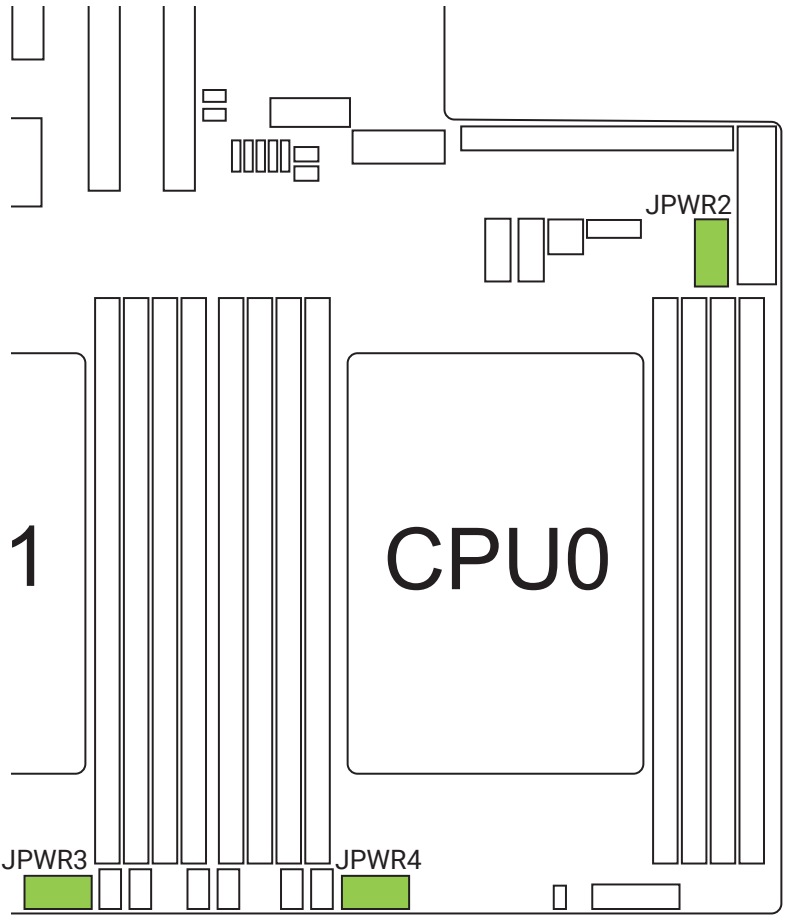
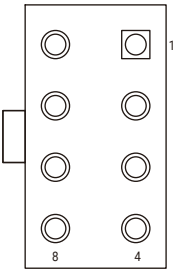

BMC I2C10 Header (JBMC)

This 1 x 3 Pin header is used to provide BMC I2C10 functionality.

1	I2C10_SCL
2	I2C10_SDA
3	GND

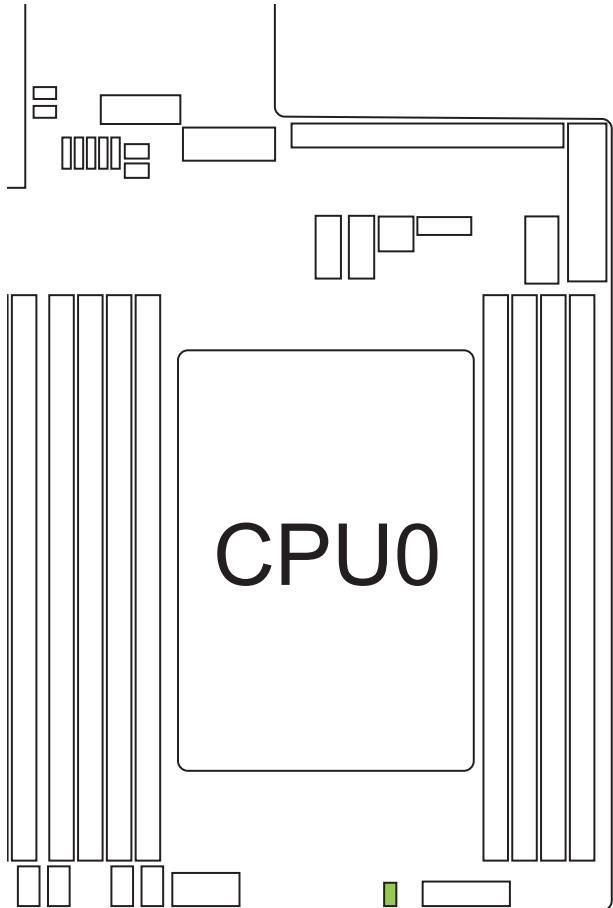
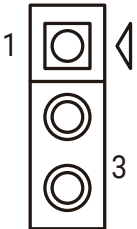

Fan Header (JFAN1~6)

This is a 4-pin connector that connects fan to motherboard.

1	GND
2	+12V
3	TACH
4	PWM

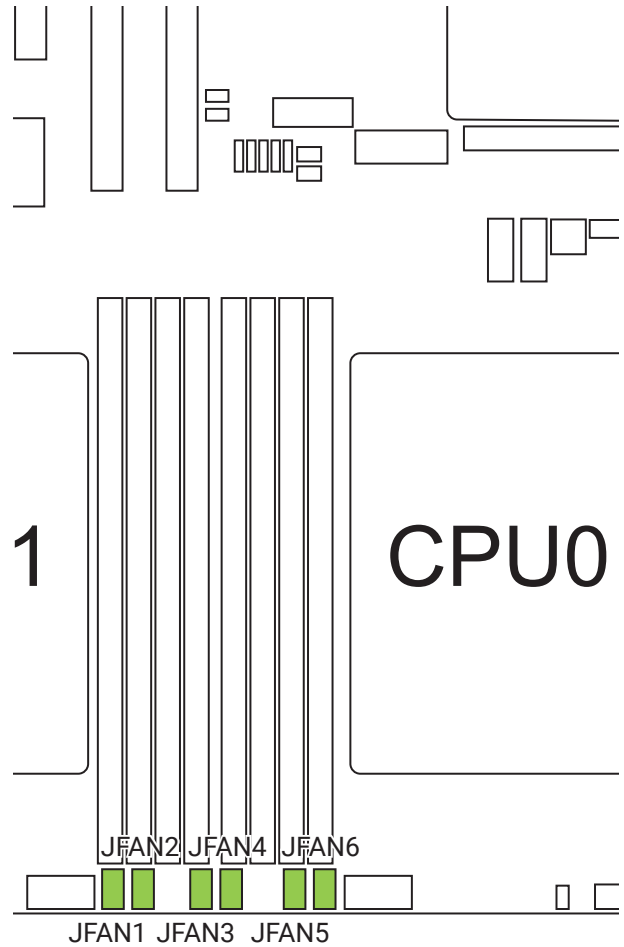
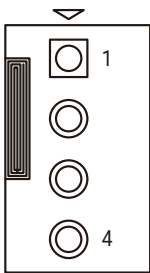

Front I/O USB Header (JUSB2_INT)

This is a 2x10-pin header that supports USB in the front panel.

KEY (no pin)	20	1	+5V
+5V	19	2	USB3_P03_ESD_RXN
USB3_P04_ESD_RXN	18	3	USB3_P03_ESD_RXP
USB3_P04_ESD_RXP	17	4	GND
GND	16	5	USB3_P03_ESD_TXN
USB3_P04_ESD_TXN	15	6	USB3_P03_ESD_TXP
USB3_P04_ESD_TXP	14	7	GND
GND	13	8	USB2_P03_ESD_DN
USB2_P04_ESD_DN	12	9	USB2_P03_ESD_DP
USB2_P04_ESD_DP	11	10	USB2_OC2_N

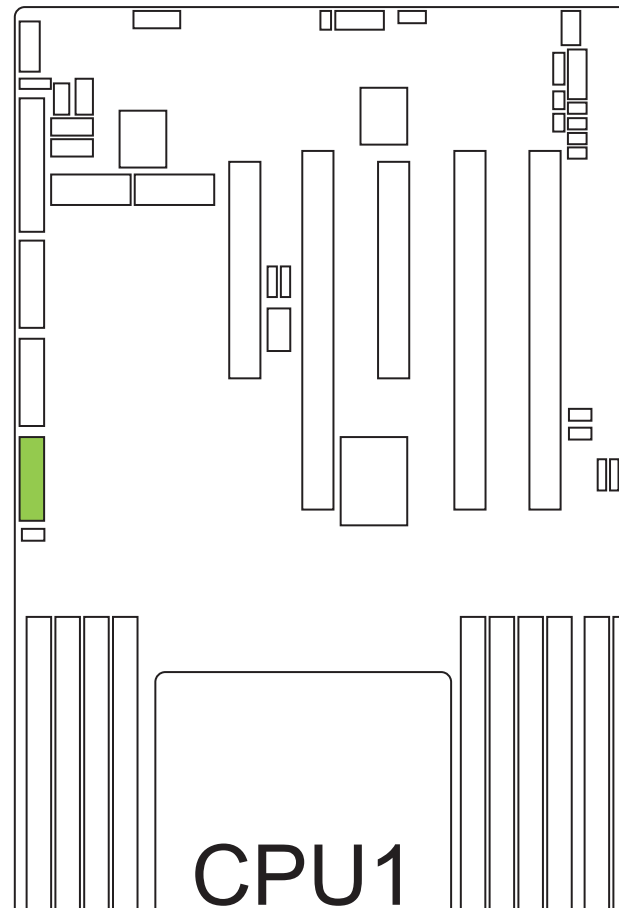
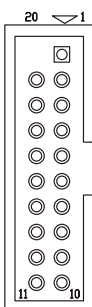

CPU PCIe Hot Plug Header (JPEHP)

This is a 2x4-pin header that provides CPU PCIe hot plug.

SMB_CPU1_SDA	2	1	SMB_CPU0_SDA
GND	4	3	GND
SMB_CPU1_SCL	6	5	SMB_CPU0_SCL
SMB_CPU1_ALERT#	8	7	SMB_CPU0_ALERT#

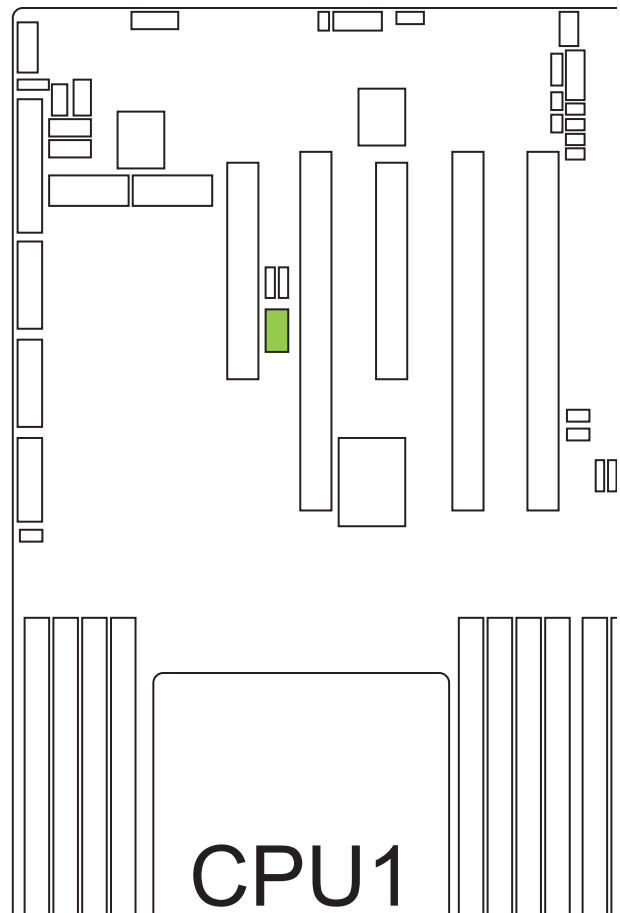
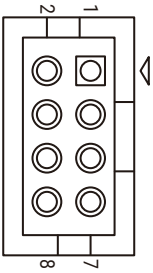

Front Panel Header (JFRONT)

This is a 2x12-pin header that supports the management of switches and controls from the front panel.

+3.3V_DUAL	2	1	PWR_LED+
+5VSB	4	3	KEY (no pin)
UID_LED#	6	5	PWR_LED-
SYS_HEALTH#2	8	7	+3.3V
SYS_HEALTH#1	10	9	HDD_LED#
LAN1_LINK_UP	12	11	SW_PWR_BTN#
LAN1_TRAFFIC	14	13	GND
I2C8SDA	16	15	SW_RST_BTN#
I2C8SCL	18	17	GND
INTRUDER#	20	19	UID_SW_IN#
LAN2_LINK_UP	22	21	+3.3V_DUAL
LAN2_TRAFFIC	24	23	FP_NMI_BTN

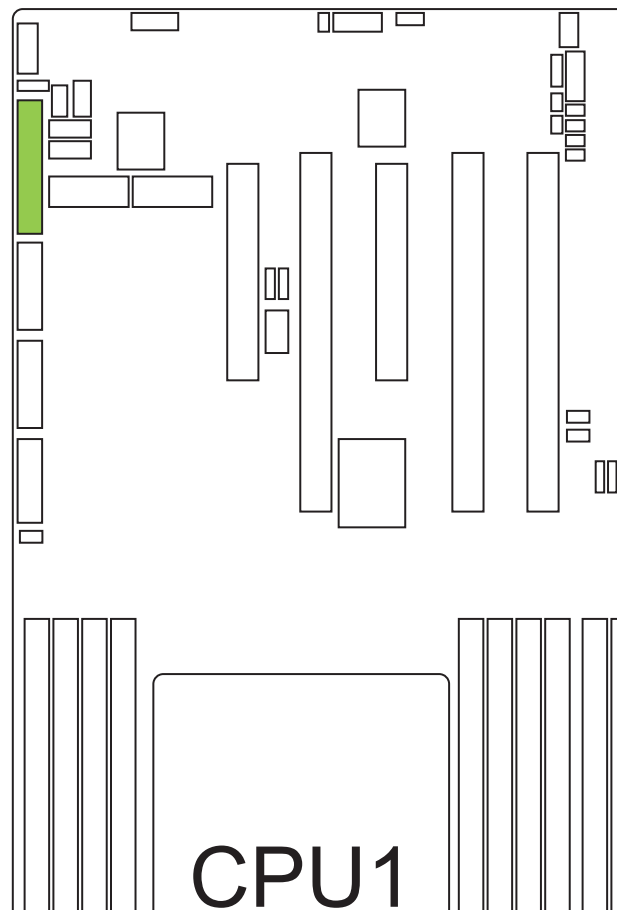
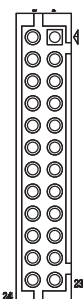

IPMB Header (JIPMB)

This is a 1x4-pin header is used to provide IPMB functionality.

1	IPMB_SDA
2	GND
3	IPMB_SCL
4	N.C.

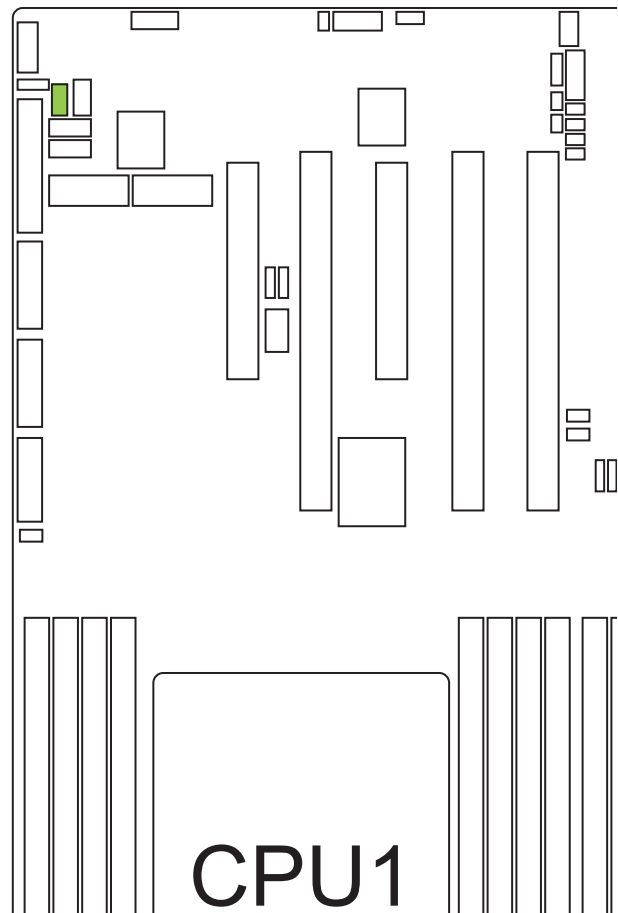
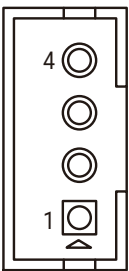

PLD Download Header (JPLD)

This 2x4-pin header is that supports PLD(Programmable Logical Device) download cable.

GND	2	1	JTAG_TCK
+3.3V_DUAL	4	3	JTAG_TDO
JTAG_EN	6	5	JTAG_TMS
FORCE_EN	8	7	JTAG_TDI

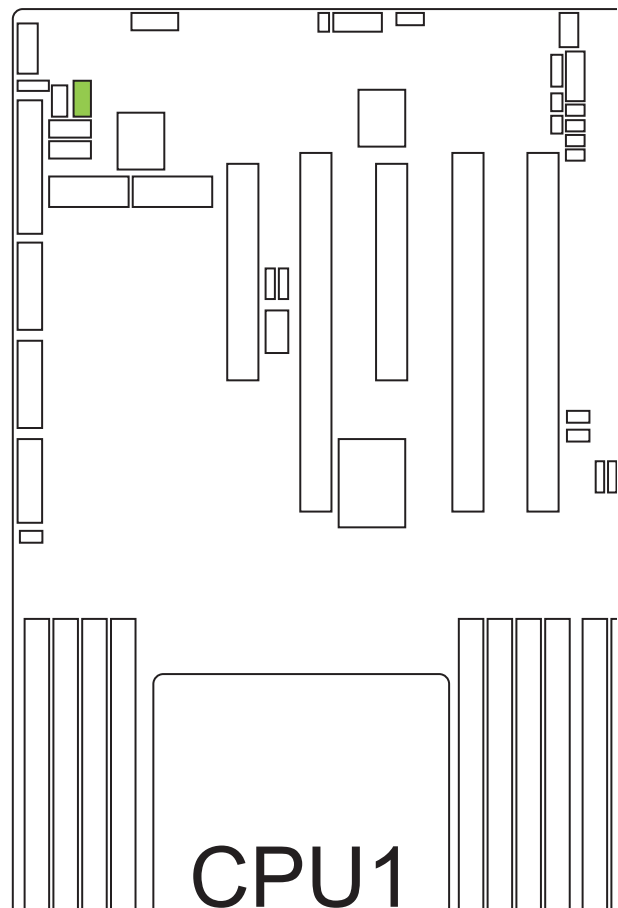
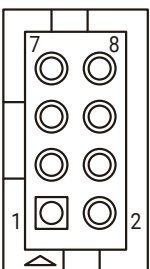

BMC GPIO Header (JBMC_GPIO)

This is a 1x6-pin header is used to provide BMC GPIO(General Purpuse Input and Output).

1	EXTRST#
2	BMC_GPY1
3	BMC_GPY0
4	I2C9SDA
5	I2C9SCL
6	GND

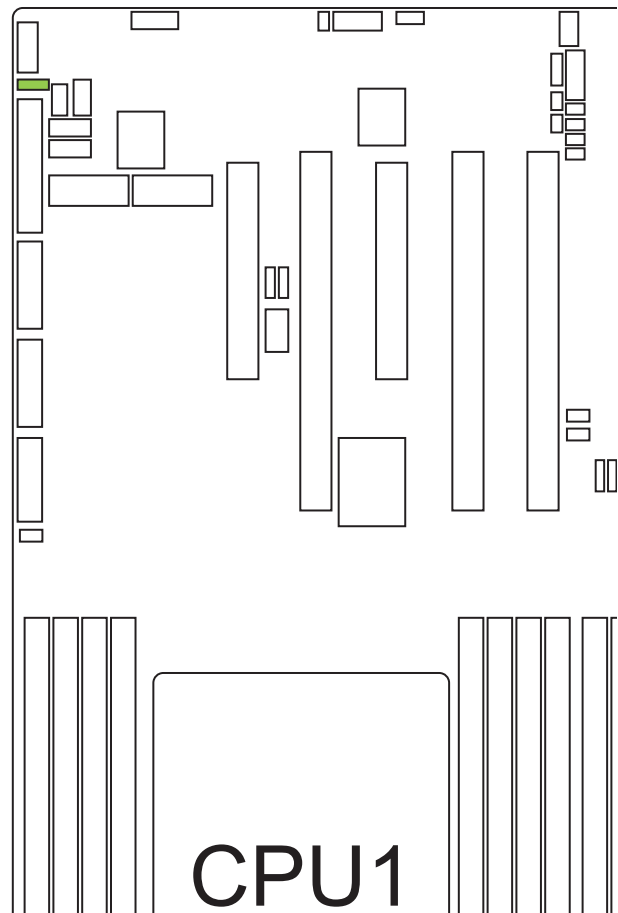
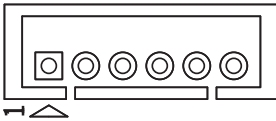

3.6 Jumper Definition

J12 SSD1 PCIE/SATA Select Jumper (J15)

This is a 3-pin jumper that configures PCIE/SATA SSD1.

J15	Setting	
Pin1-2	SATA	Default
Pin2-3	PCIe X4	

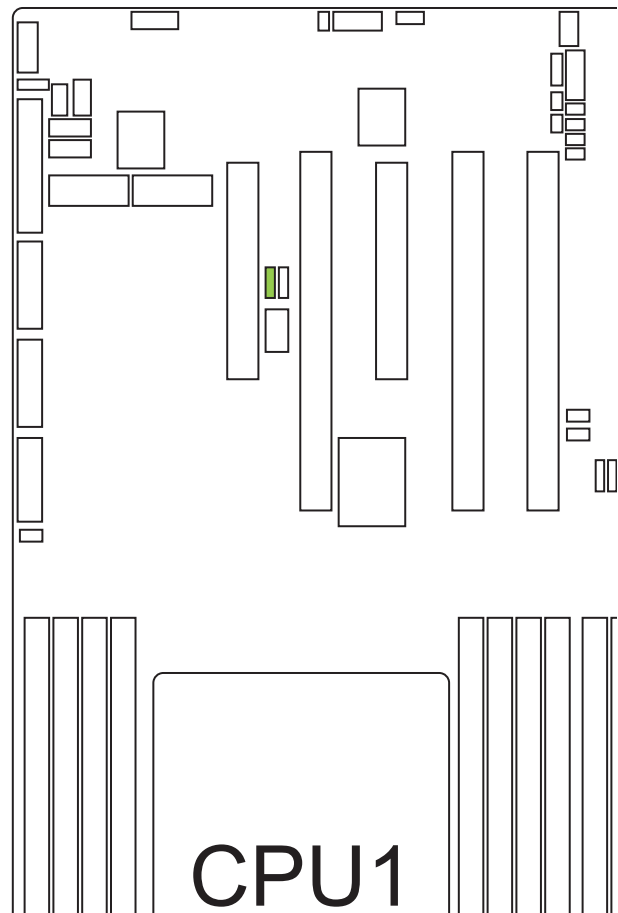
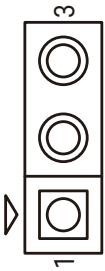

J12 SSD2 PCIE/SATA Select Jumper (J16)

This is a 3-pin jumper that configures PCIE/SATA SSD2.

J16	Setting	
Pin1-2	SATA	Default
Pin2-3	PCIe X4	

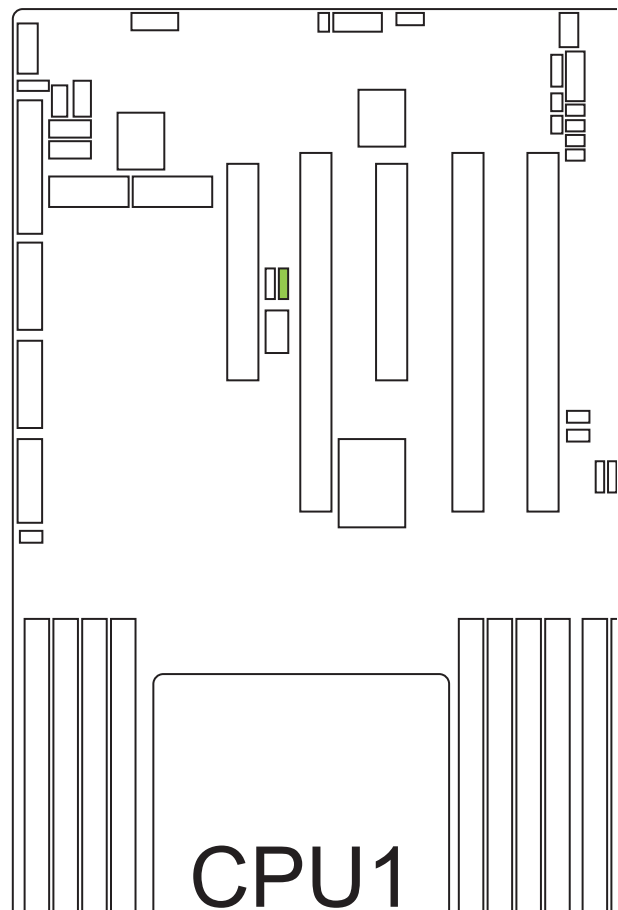
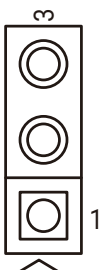

No Reboot (Watch Dog) Jumper (J1)

This is a 2-pin jumper that enables the watchdog timer without reboot.

J1	Setting	
Short	Enable	
Open	Disable	Default

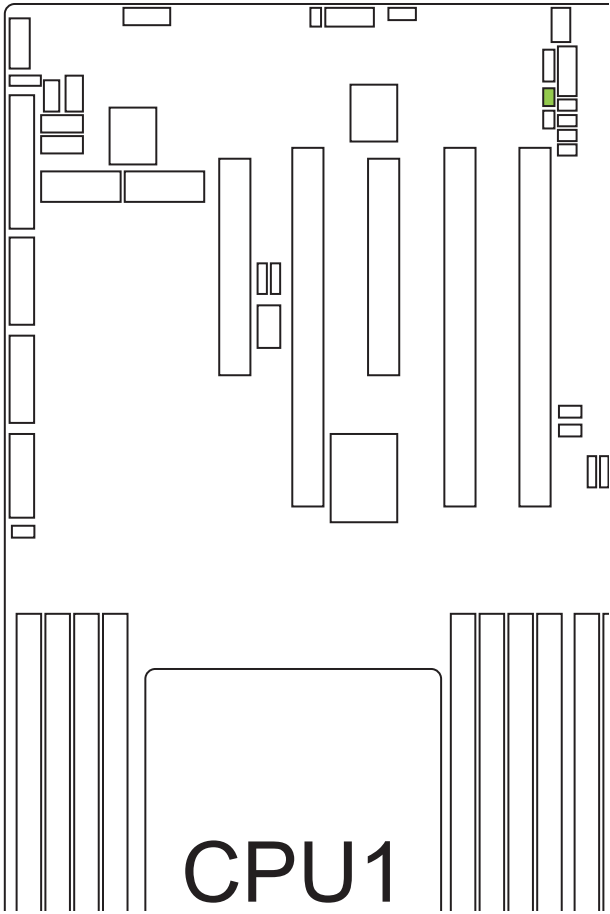

BMC Debug Port Select Jumper (J2)

This is a 2-pin jumper that configures BMC debug port.

J2	Setting	
Short	JCOM1	
Open	JBMC_DP	Default

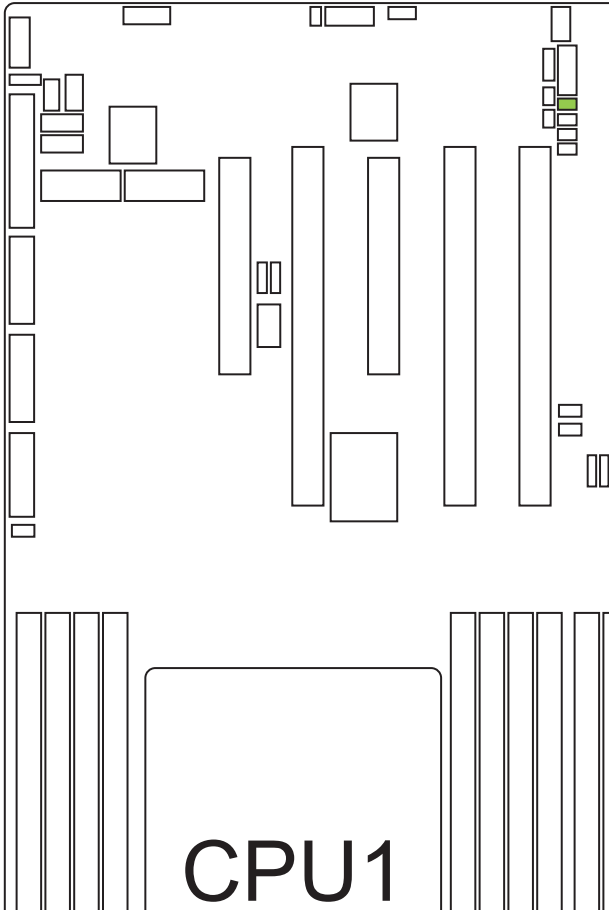
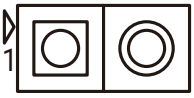

ME Force Recovery Mode Jumper (J3)

This is a 2-pin jumper that enables ME firmware to recovery mode.

J3	Setting	
Short	ME Recovery Mode	
Open	Normal	Default

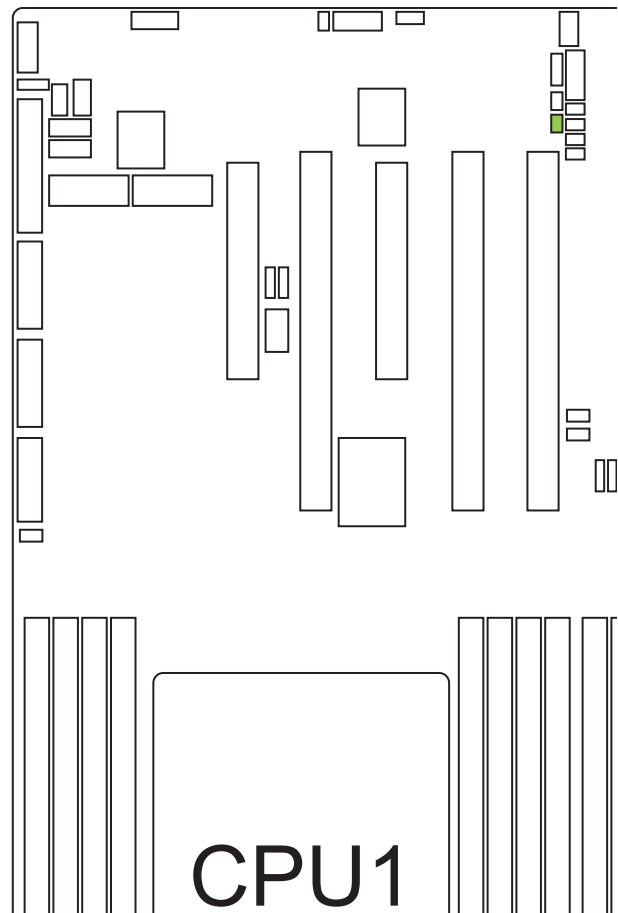
**BMC SoC Flash Configuration Jumper (J4)**

This is a 2-pin jumper that enables BMC SOC Flash.

J4	Setting	
Short	Enable	
Open	Disable	Default

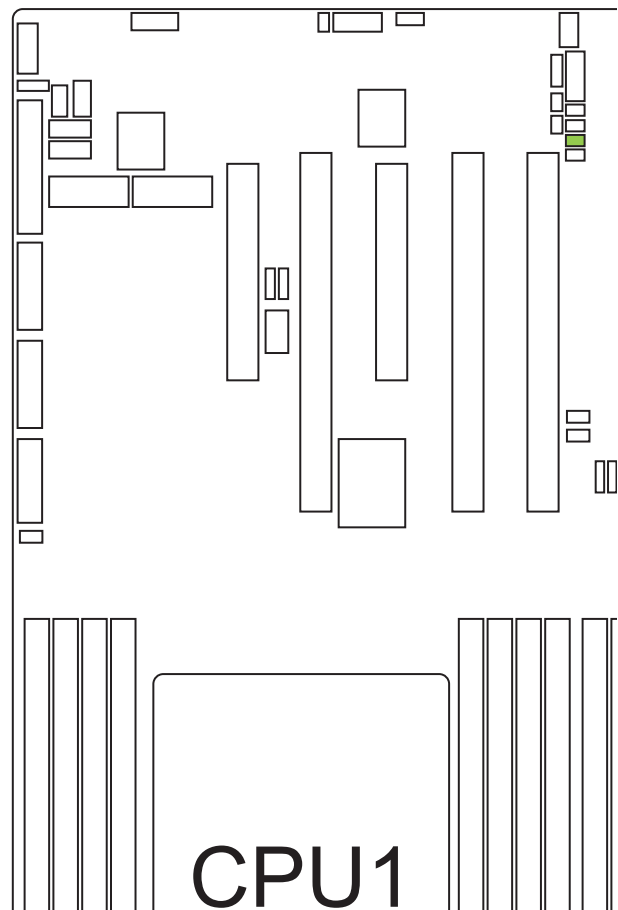

Flash Descriptor Security override Jumper (J5)

This is a 2-pin jumper that enables the override of flash descriptor.

J5	Setting	
Short	Flash Security override	
Open	Normal	Default

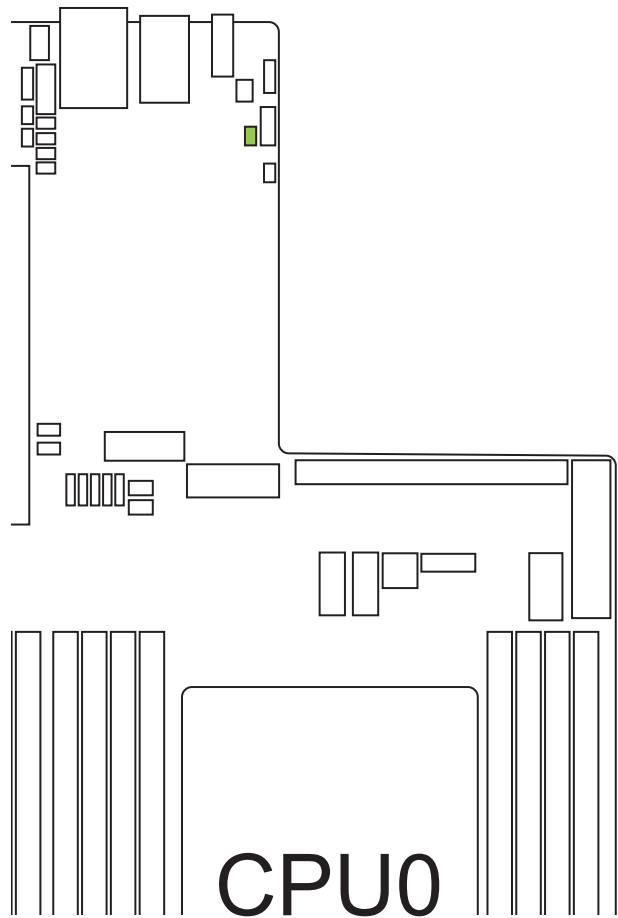

BIOS Recovery Mode Jumper (J6)

2-pin jumper that enables the recovery of the last functional version of BIOS.

J6	Setting	
Short	BIOS Recovery Mode	
Open	Normal	Default

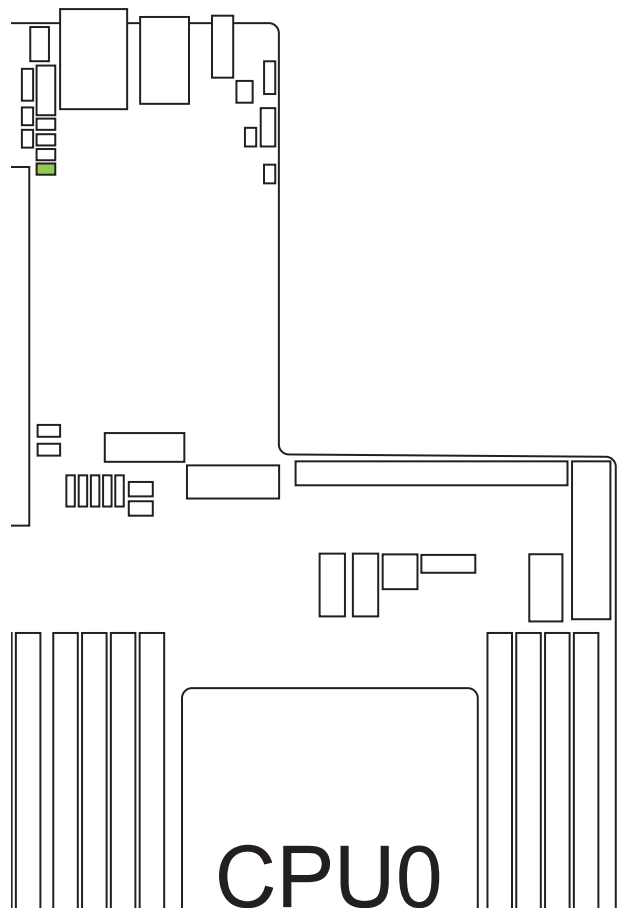
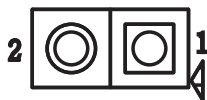

BMC Reset Jumper (JBMC_RST)
This is a 2-pin jumper that reboots the BMC.

JBMC_RST	Setting	
Short	Reset BMC	
Open	Normal	Default

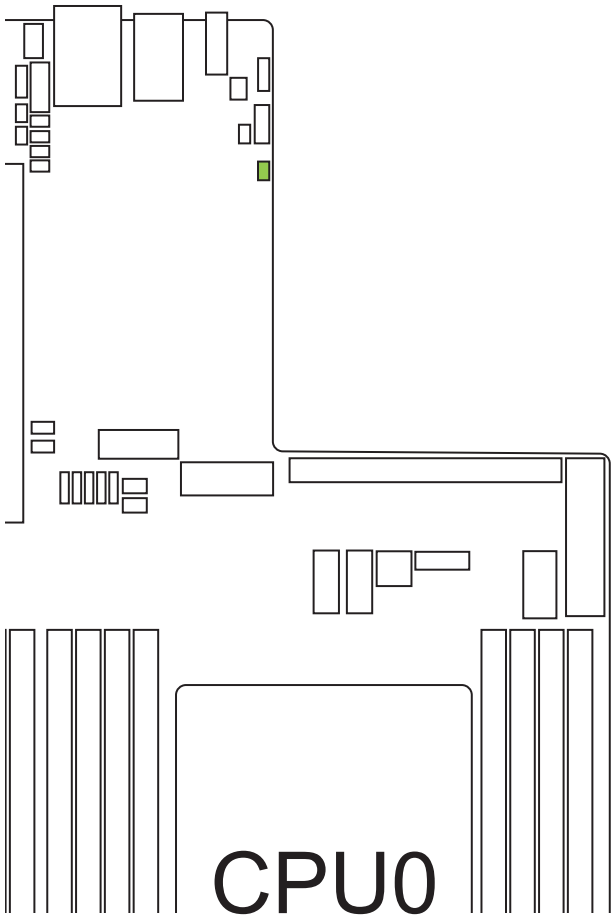
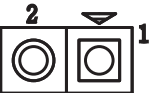

BMC ARM Disable Jumper (JBMC_DIS)
This is a 2-pin jumper that disables BMC ARM support.

JBMC_DIS	Setting	
Short	Disable	
Open	Normal	Default

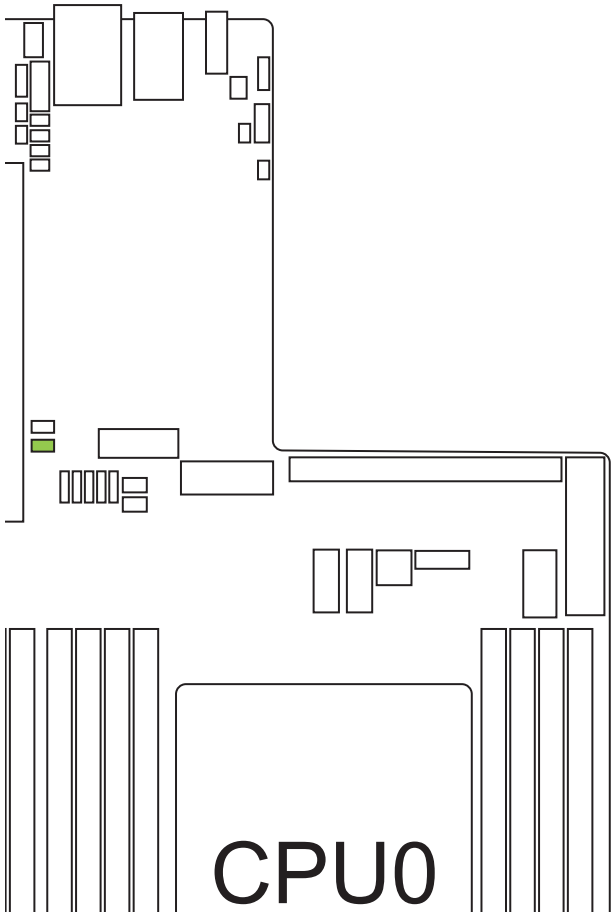

CMOS Jumper (JCMOS)

This is a 3-pin jumper that resets BIOS changes to default value.

JCMOS	Setting	
Pin1-2	Normal	Default
Pin2-3	Clear CMOS	

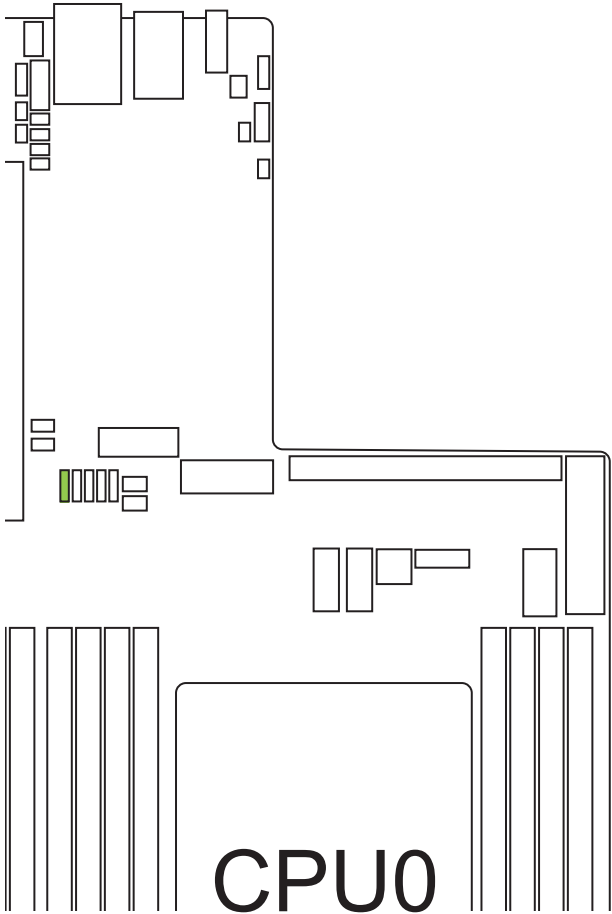
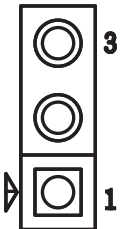

PECI Master Select Jumper (JPECI)

This is a 3-pin jumper that enables PECI access to BMC for DTS (Digital Thermal Sensor).

JPECI	Setting	
Pin1-2	PCH	Default
Pin2-3	BMC	

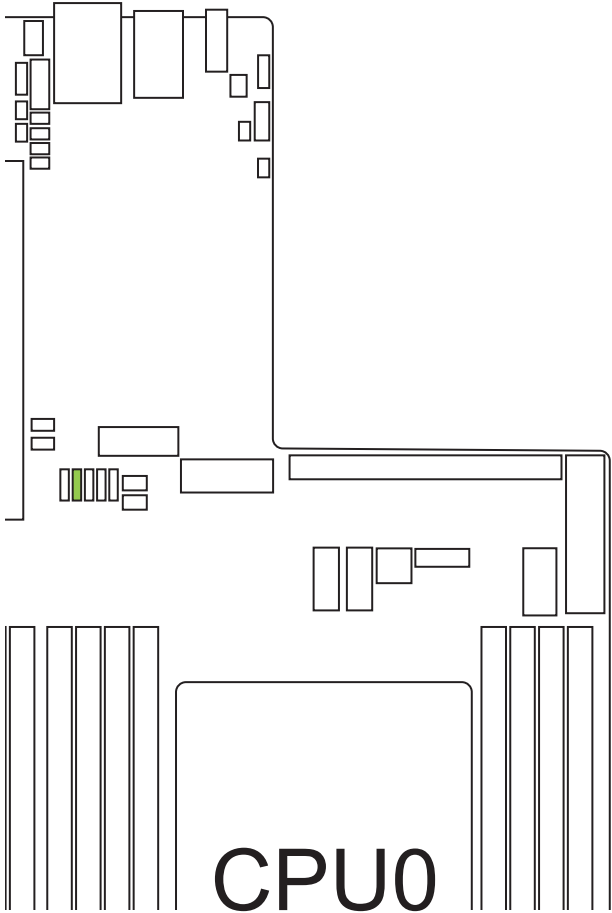
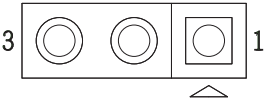

BMC NCSI Select Jumper (JNCSI_SEL)

This is a 3-pin jumper that enables connection between BMC and other NICs.

JNCSI_SEL	Setting	
Pin 1-2	I210	Default
Pin 2-3	OCF	

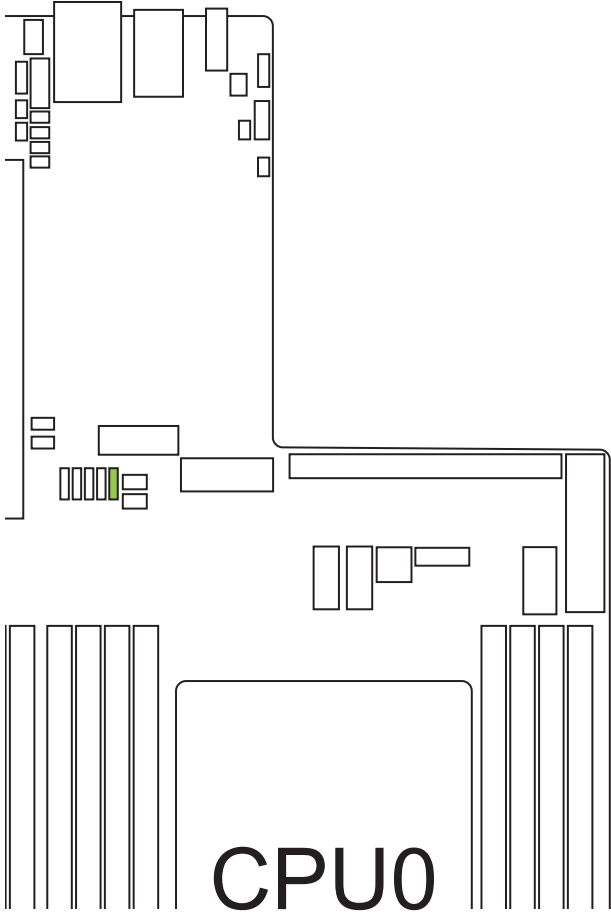
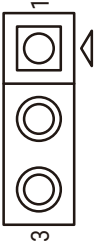

3.7 Internal LED

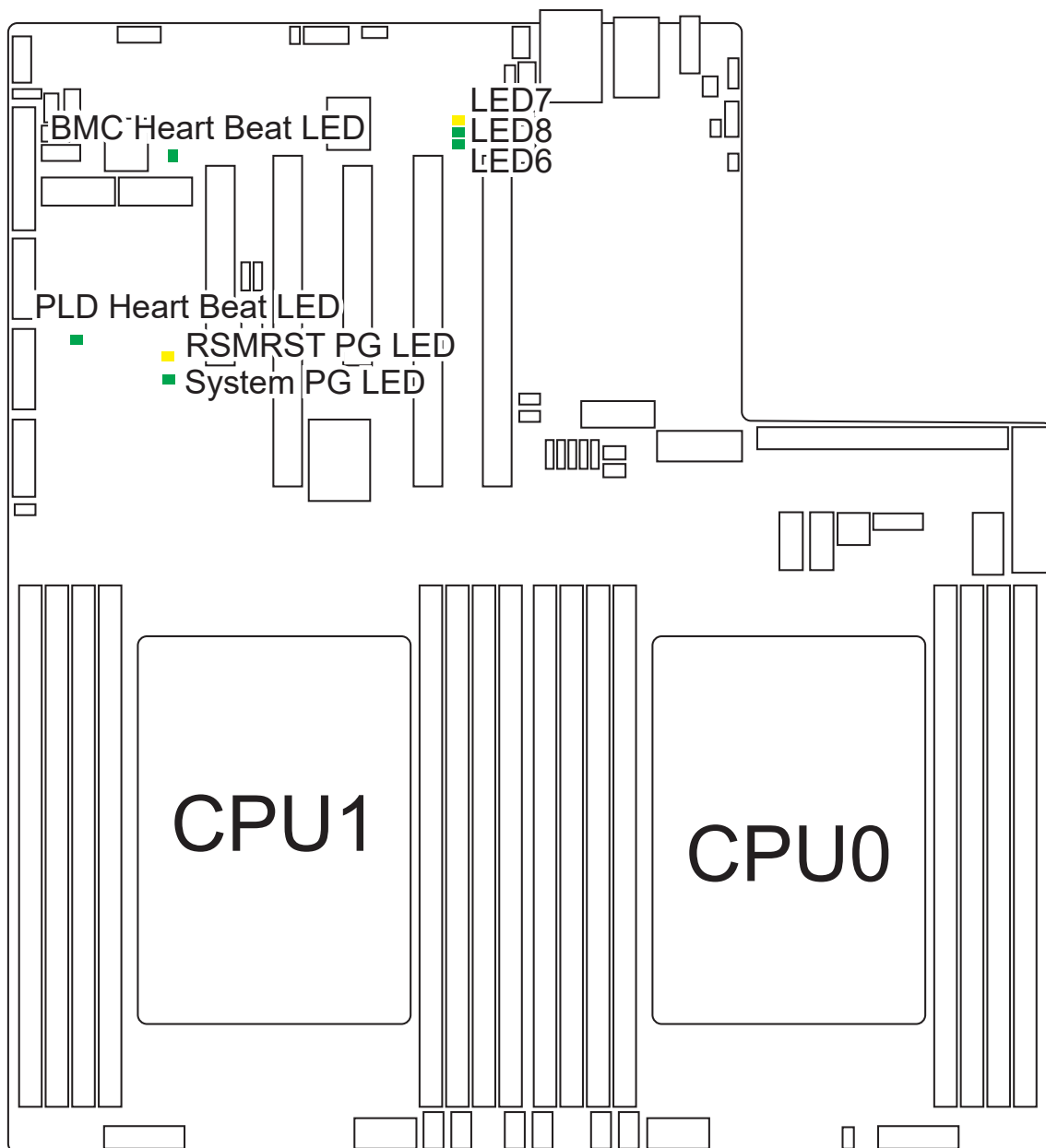

Item	Color	Behavior
BMC HEART BEAT LED	Green (Blinking)	BMC activity is detected.
	Green	BMC is not active.
PLD HEART BEAT LED	Green (Blinking)	PLD activity is detected.
	Green	PLD is not active.
SYSTEM PG LED	Green	System power good is ready.
	Off	System power good is not ready.
RSMRST PG LED	Yellow	Resume Well Reset is ready.
	Off	Resume Well Reset is not ready.
LAN2 (I210) LED	Yellow (LED7)	Link speed: 1G.
	Green (LED8)	Link speed: 100M.
	Green (LED6)	LAN is active.

3.8 Drive Backplane: 4 Bay

3.8.1 Placement

Top view



Bottom view

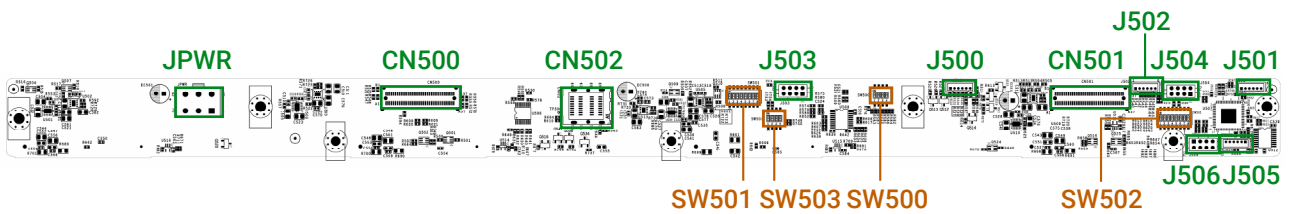

3.8.2 Connector

UBM Connector (J500)

1	BP_PWRDIS_Q6
2	BP_PWRDIS_Q7
3	BP_M4
4	BP_M5
5	BP_M6
6	BP_M7

UBM Connector (J501)

1	BP_LED7
2	SSD_RSTOUT_N4
3	SSD_RSTOUT_N5
4	SSD_RSTOUT_N6
5	SSD_RSTOUT_N7
6	CPRSNT_N2

UBM Connector (J502)

1	BP_PWRDIS_Q4
2	BP_PWRDIS_Q5
3	BP_M0
4	BP_M1
5	BP_M2
6	BP_M3

UBM Connector (J505)

1	BP_LRA
2	BP_LRF
3	BP_LRL
4	BP_LED4
5	BP_LED5
6	BP_LED6

SGPIO / UBM0 / BMC I2C Connector (J506)

SSATA_DATAOUT	2	1	SMB_SATA_CLK0
SSATA_LOAD	4	3	SMB_SATA_DAT0
SSATA_CLOCK	6	5	UBM0_SCL
GND	8	7	UBM0_SDA

SGPIO / UBM2 / BMC I2C Connector (J503)

SATA_DATAOUT	2	1	SMB_SATA_CLK1
SATA_LOAD	4	3	SMB_SATA_DAT1
SATA_CLOCK	6	5	UBM2_SCL
GND	8	7	UBM2_SDA

PCIe Hot-Plug SMBus Connector (J504)

SMB_BP_SHP1_SCL	2	1	SMB_BP_SHP0_SCL
SMB_BP_SHP1_SDA	4	3	SMB_BP_SHP0_SDA
BP_SHPINT_OUT_N1	6	5	BP_SHPINT_OUT_N0
GND	8	7	GND

3.8.3 LED Indicator

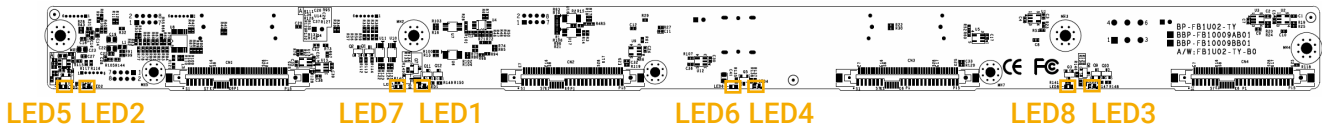

Indicator	Color	Behavior
LED5	Blue (Blinking)	CN1 SSD activity.
	Off	CN1 SSD activity not detected.
LED2	Red	CN1 SSD fault.
	Green	CN1 SSD local.
LED7	Blue (Blinking)	CN2 SSD activity.
	Off	CN2 SSD activity not detected.
LED1	Red	CN2 SSD fault.
	Green	CN2 SSD local.
LED6	Blue (Blinking)	CN3 SSD activity.
	Off	CN3 SSD activity not detected.
LED4	Red	CN3 SSD fault.
	Green	CN3 SSD local.
LED8	Blue (Blinking)	CN4 SSD activity.
	Off	CN4 SSD activity not detected.
LED3	Red	CN4 SSD fault.
	Green	CN4 SSD local.

3.8.4 Cable Routing

Top view



Bottom view

Connects 6-pin plug from motherboard

Connects the data cable to the motherboard

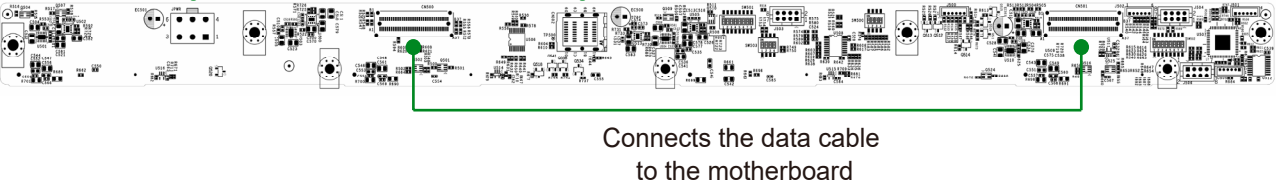

Chapter 4. BIOS Configuration Settings

This chapter demonstrates how to configure the UEFI BIOS settings in your system device. You can enter the BIOS screen during system startup.

To enter BIOS configuration settings,

- Press **Esc** key during the Power-On-Self-Test (POST)

To enter BIOS after POST, you have to restart the system by using one of the three methods:

- Press **Ctrl + Alt + Delete**.
- Press the reset button on the system chassis.
- Turn the system off and on.

NOTE



- The following pages provide the details of BIOS menu. Please be noted that the BIOS menu are continually changing due to the BIOS updating. The BIOS menu provided are the most updated ones when this manual is written.
- The default value for each BIOS option key may vary per system. The [default] key is for reference only.

4.1 Navigation Keys

The navigation keys are listed below.

Function Key	Description
< ↑ > < ← > < → > < ↓ >	Select item.
< Enter >	Select and enter sub-screen.
< + > < - >	Modify selected option.
< F1 >	General help.
< F2 >	Previous Value.
< F3 >	Optimized defaults.
< F4 >	Save & Exit.
< F5 > < F6 >	Change values.
< F7 >	Discard Change and Exit.
< F9 >	Load Optimal Default for all values.
< F10 >	Save changes and exit.
< F12 >	Print Screen.
< Esc >	Exit the current menu screen.

4.2 BIOS Menu

4.2.1 Menu

Press **←** and **→** to select the options of the menu bar.

Press **Enter** to access the option screen.

Menu	Description
Main	Displays basic system information and date & time.
Advanced	Allows configuration of advanced system settings.
Platform Configuration	Allows configuration of platform settings such as PCH, miscellaneous, and server ME configuration.
Socket Configuration	Allows configuration of socket settings such as processor, Common RefCode, UPI, and memory configurtaion.
Server Management	Allows configuration of timer, System Event Log, and BMC network.
Security	Sets passwords and security functions.
Boot	Sets boot options such as Quick Boot or USB Boot.
Exit	Save changes and exit, discard changes and exit, discard changes, or load optimal or fail-safe defaults.

4.2.2 Startup

① Press **DEL** or **ESC** to run the BIOS setup procedure.

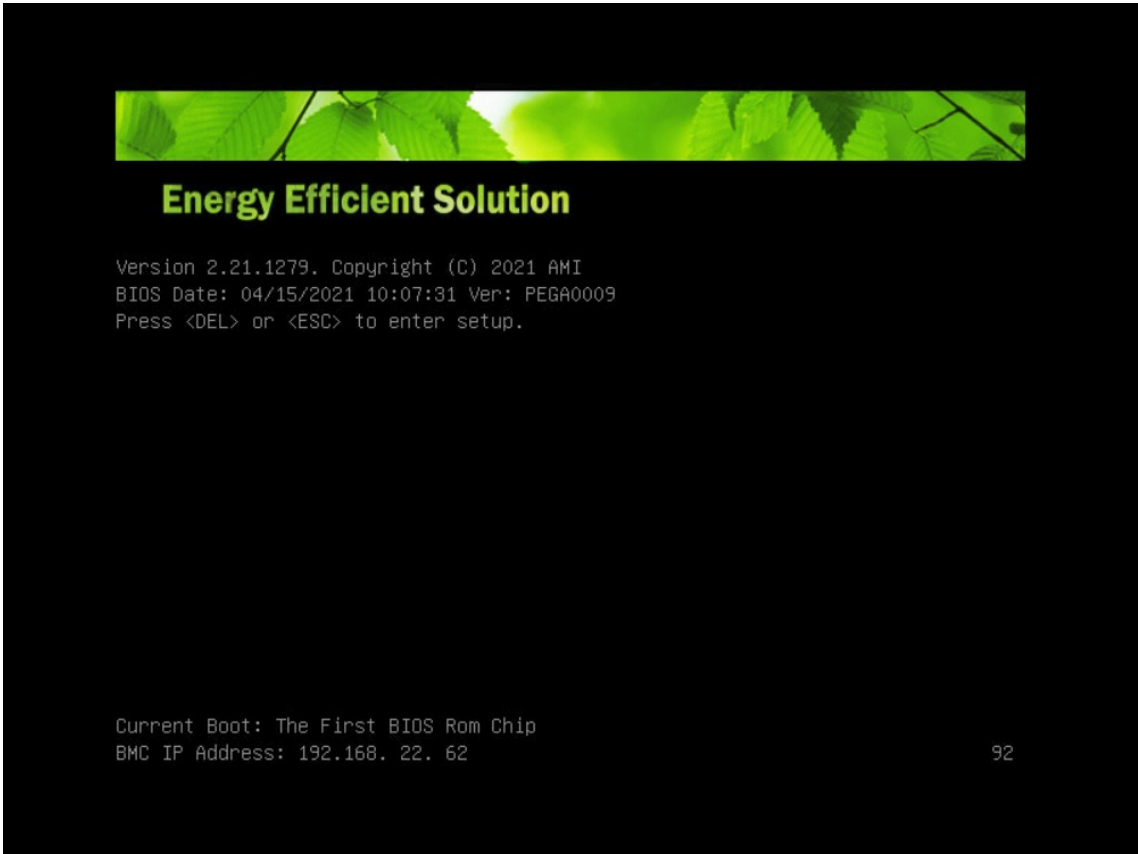

4.3 Main

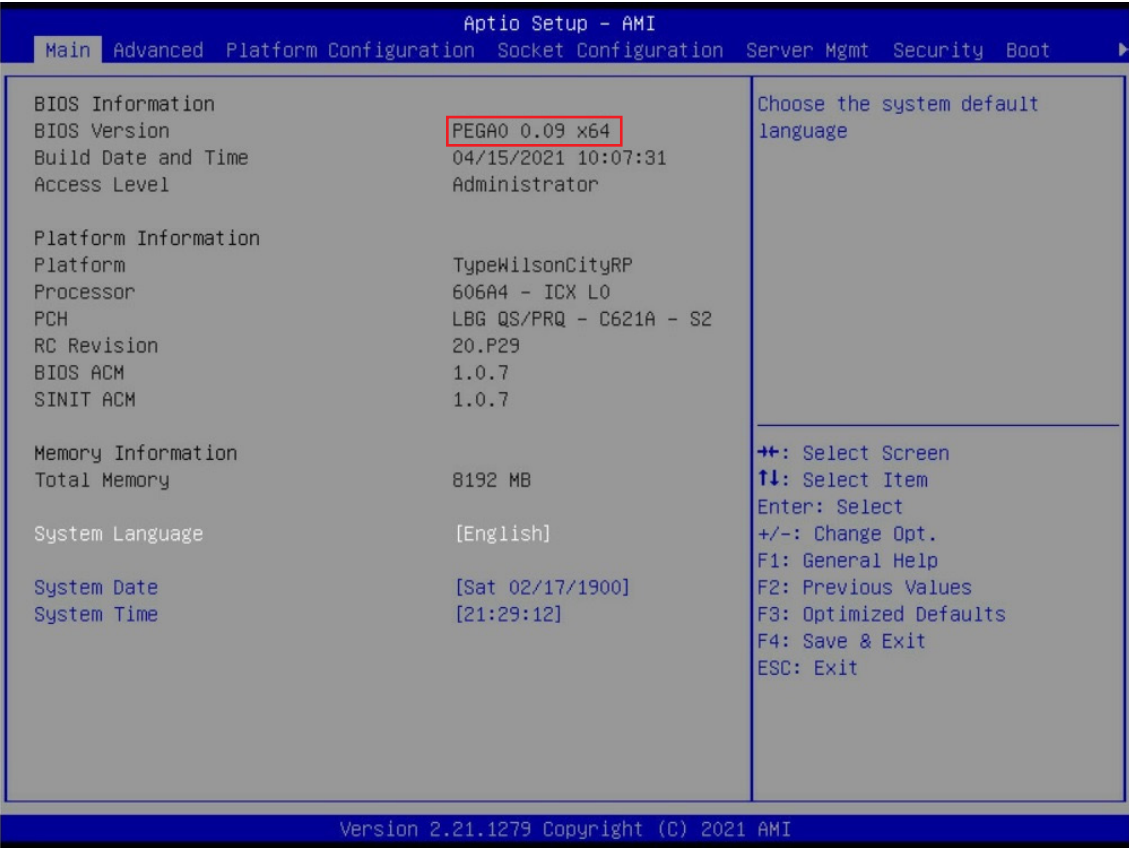

4.3.1 Main

Main	
System Language	Configures the language used in the system.
System time	Configures the current time.
System date	Configures the current date.

4.4 Advanced

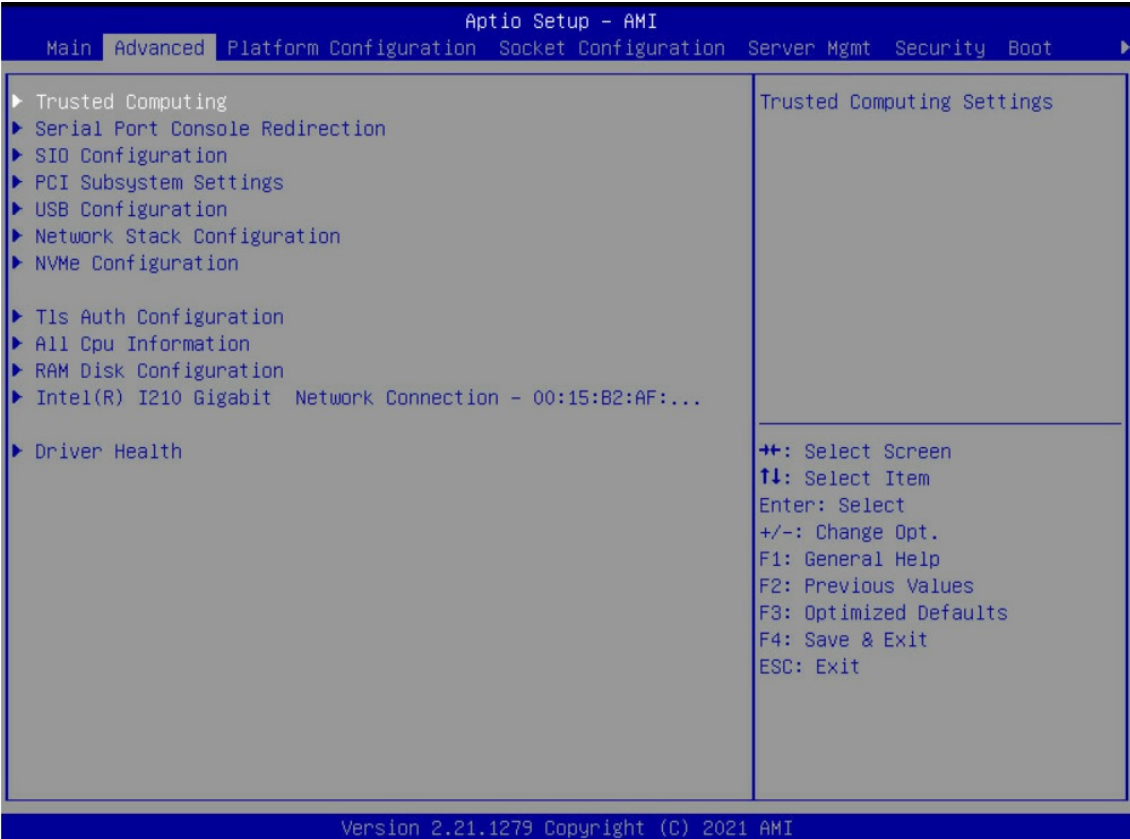

4.4.1 Trusted Computing

Trusted Computing Settings.

Trusted Computing	
Security Device Support	Enables/disables BIOS support for security device. Enable Disable
SHA-1/256/384 PCR Bank	Enables/disables SHA-1/SHA-256/SHA-384 PCR Bank. Enable Disable
Pending operation	Schedules an operation for the security device. NOTE: Your computer will reboot during restart in order to change the state of the security device. None TPM Clear
Platform Hierarchy	Enables/disables platform hierarchy. Enable Disable
Storage Hierarchy	Enables/disables storage hierarchy. Enable Disable
Endorsement Hierarchy	Enables/disables endorsement hierarchy. Enable Disable
TPM 2.0 UEFI Spec Version	Select the TCG2 spec version support. • TCG_1_2: The compatible mode for Win8/10. • TCG_2: Support new TCG2 protocol and event format for win10 or later. TCG_1_2 TCG_2
Physical Presence Spec Version	Select to Tell O.S. to support PPI spec version 1.2 or 1.3. NOTE: Some HCK tests might not support 1.3. 1.2 1.3
Device Select	• TPM 1.2: TPM 1.2 will restrict support to TPM 1.2 devices. • TPM 2.0: TPM 2.0 will restrict support to TPM 2.0 devices. • Auto: Auto will support both with the default set to TPM 2.0 devices if not found, TPM 1.2 devices will be enumerated. None TPM 1.2 TPM 2.0

4.4.2 Serial Port Console Redirection

Serial Port Console Redirection.

Serial Port Console Redirection			
Console Redirection	Enables/disables console redirection.		
	Enable	Disable	
Legacy Console Redirection Settings	Redirection COM Port	Select a COM port to display redirection of Legacy OS and Legacy OPROM Messages.	
		COM0	COM1
	Resolution	On Legacy OS, the number of rows and columns supported redirection.	
		80x24	80x25
Redirect After POST	<ul style="list-style-type: none"> When Bootloader is selected, then Legacy Console Redirection is disabled before booting to legacy O.S. When Always Enable is selected, then Legacy Console Redirection is enabled for legacy O.S. 		
	Always Enable	Bootloader	

4.4.3 SIO Configuration

SIO Configuration.

SIO Configuration				
[*Active*] Serial Port 1/2/3/4	Use this device	Enables/disables this logical device.		
		Enable	Disable	
	Possible	Allows the user to change the device user settings. New settings will be reflected on this setup page after system restarts.		
		Use Automatic Settings	IO=3F8h; IRQ=4: DMA;	IO=3F8h; IRQ=3, 4, 7, 10, 11, 12; DMA;
	IO=2F8h; IRQ=3, 4, 7, 10, 11, 12; DMA;	IO=3E8h; IRQ=3, 4, 7, 10, 11, 12; DMA;	IO=2E8h IRQ=3, 4, 7, 10, 11, 12; DMA;	

4.4.4 PCI Subsystem Settings

PCI, PCI-X and PCI Express Settings.

PCI Subsystem Settings			
Above 4G decoding	Enables/disables 64 bit capable devices to be decoded in above 4G address space (only if system supports 64 bit decoding).		
	Enable	Disable	
SR-IOV Support	If system has SR-IOV capable PCIe devices, this option enables or disables Single Root IO Virtualizaion Support.		
	Enable	Disable	
BME DMA Mitigation	Re-enable Bus Master Attribute disabled during PCI enumeration for PCI Bridges after SMM Lcked.		
	Enable	Disable	

4.4.5 USB Configuration

USB Configuration Parameters.

USB Configuration				
XHCI Hand-off	This is a workaround for OSes without XHCI ownership change should be claimed by XHCI driver			
	Enable	Disable		
SB Mass Storage Driver Storage	Enables/disables USB Mass Storage Driver Support			
	Enable	Disable		
POST 60/64 Emulation	Enables I/O port 60h/64h emulation support. This should be enabled for the complete USB keyboard legacy support for non-USB aware OSes.			
	Enable	Disable		
SB transfer time-out	The time-out value for control, bulk, and interrupt transfers.			
	1 sec	5 sec	10 sec	20 sec
Device reset time-out	USB mass storage device Start Unit command time-out.			
	10 sec	20 sec	30 sec	40 sec

Device power-up delay	Maximum time the device will take before it properly reports itself to the host controller. • Auto: For a root port, it is 100 ms; for a hub port, the delay is taken from hub descriptor.				
	Auto			Manual	
AMI Virtual CDROM0 1.00	Mass storage device emulation type. • Auto: Enumerates devices according to their media format. Optical drives are emulated as "CDROM," drives with not media will be emulated according to drive type.				
	Auto	Floppy	Forced FDD	Hard Disk	CD-ROM
AMI Virtual HDisk0 1.00	Mass storage device emulation type. • Auto: Enumerates devices according to their media format. Optical drives are emulated as "CDROM," drives with not media will be emulated according to drive type.				
	Auto	Floppy	Forced FDD	Hard Disk	CD-ROM

4.4.6 Network Stack Configuration

Network Stack Settings.

Network Stack Configuration	
Network Stack	Enables/disables UEFI Network Stack.
	Enable Disable

4.4.7 T1s Auth Configuration

Select T1s Auth Configuration.

T1s Auth Configuration			
Server CA Configuration	Configures server CA.		
	Enroll Cert	Enroll Cert Using File	Enroll Cert using file.
		Commit Changes and Exit	Commit changes and exit.
		Discard Changes and Exit	Discard changes and exit.
Delete Cert			

4.4.8 RAM Disk Configuration

Adds/Removes RAM disks.

RAM Disk Configuration			
Disk Memory Type	Specifies type of memory to use from available memory pool in system to create a disk.		
	Boot Service Data Reserved		
Create Raw	Creates a raw RAM disk.		
	Size (Hex)	The valid RAM disk size should be multiples of RAM disk block size. 1	
		Create & Exit	Creates a new RAM disk with the given starting and ending address.
		Discard & Exit	Discards and exits.
Create from file	Creates a RAM disk from a given file.		
RAM Disk 0	Select to remove.		
	Enable Disable		
Remove selected RAM disk(s)	Removes selected RAM disk(s).		

4.4.9 Driver Health

Provides Health Status for the Drivers/Controllers.

Driver Health	
Network Stack	Enables/disables UEFI Network Stack.
	Enable Disable

4.5 Platform Configuration

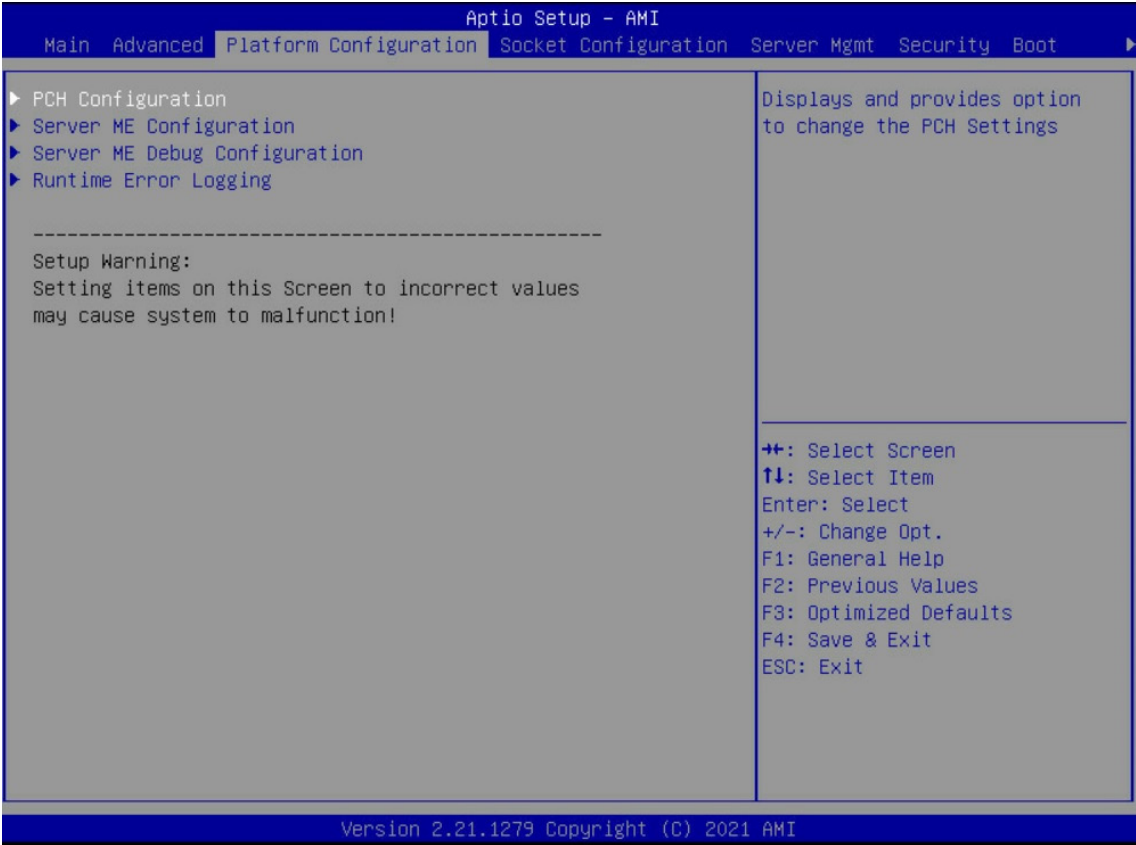

4.5.1 PCH Configuration

Displays and provides option to change the PCH Settings.

PCH Configuration			
PCH Configuration	Enables/disables Intel(R) IO controller hub devices.		
	External SSC Enable - CK420	Enable Spread Spectrum - only affects external clock generator. Enable Disable	
	PCIe P11 SSC	PCIe P11 SSC percentage. • Auto: Keep hw default, no BIOS override. Range is 0.0%-2.0% Auto Disable 0.5%	
	Shutdown Policy	Allows to configure Shutdown Policy Select in General Interrupt Register. Available modes are INIT and PLTRST. INIT PLTRST	
PCH SATA Configuration	SATA Contoller	Enables/disables SATA controller. Enable Disable	
	Configure SATA as	Identify the SATA port is connected to solid state drive or hard disk drive. AHCI RAID	
	SATA test mode	Enables/disables SATA test mode. Enable Disable	
	SATA Mode options	SATA HDD Unlock	SATA mode related options. Enable: HDD password unlock is enabled in the OS. Enable Disable
		SATA LED locate	If enabled LED/SGPIO hardware is attached. Enable Disable
	Support Agressive Link Power	Enables/disables SALP. Enable Disable	

PCH SATA Configuration	Hot Plug	Designates this port as hot pluggable.				
		AHCI		RAID		
	Configure as eSATA	Configures port as external SATA (eSATA).				
		Enable		Disable		
	Mechanical Presence Switch	Controls reporting if this port has a mechanical presence switch. NOTE: Requires hardware support.				
		Enable		Disable		
Spin Up Device	If enabled for any ports Staggered Spin Up will be performed and only the drives which have this option enabled will spin up at boot. Otherwise all drives spin up at boot.					
	Enable		Disable			
SATA Device Type	Identify the SATA port is connected to solid state drive or hard disk drive.					
	Hard Disk Drive		Solid State Drive			
SATA Topology	Identify the SATA topology if it is the default or ISATA or Flex or DirectConnect or M2.					
	Unknown	ISATA	Direct Connect	Flex	M2	
PCH sSATA Configuration	sSATA Controller	Enables/disables SATA controller.				
		Enable		Disable		
	Configure sSATA as	Identify the SATA port is connected to solid state drive or hard disk drive.				
	AHCI		RAID			
SATA test mode	Enables/disables SATA test mode.					
	Enable		Disable			
PCH sSATA Configuration	SATA Mode options	SATA mode related options.				
		SATA HDD Unlock	Enable: HDD password unlock is enabled in the OS.			
		Enable		Disable		
		SATA LED locate	If enabled LED/SGPIO hardware is attached.			
		Enable		Disable		
	Support Aggressive Link Power	Enables/disables SALP.				
		Enable		Disable		
	sSATA Port 0-5	Enables/disables SATA port.				
		Enable		Disable		
	Hot Plug	Designates this port as hot pluggable.				
		AHCI		RAID		
	Configure as eSATA	Configures port as external SATA (eSATA).				
	Enable		Disable			
Mechanical Presence Switch	Controls reporting if this port has a mechanical presence switch. NOTE: Requires hardware support.					
	Enable		Disable			
Spin Up Device	If enabled for any ports Staggered Spin Up will be performed and only the drives which have this option enabled will spin up at boot. Otherwise all drives spin up at boot.					
	Enable		Disable			
SATA Device Type	Identifies the SATA port is connected to solid state drive or hard disk drive.					
	Hard Disk Drive		Solid State Drive			
SATA Topology	Identifies the SATA Topology if it is the default or ISATA or Flex or DirectConnect or M2.					
	Unknown	ISATA	Direct Connect	Flex	M2	

USB Configuration	USB Per-Connector Disable	Selectively enables/disables each of the USB physical connector (physical port). Once a connector is disabled, any USB devices plug into the connector will not be detected by BIOS or OS.										
		Enable					Disable					
	Wake On Usb Enable	Enables/disables support for XHCI Wake on USB on connect/disconnect.										
		Enable					Disable					
XHCI BAR below 4GB		Enables to work around WSK12 KDUSB 64-bit BAR issue.										
		Enable					Disable					
ADR Configuration	Enable/Disable ADR	Enables/disables Automatic DIMM Refresh (ADR). This is not available if eADR is enabled since eADR requires ADR to be enabled.										
		Platform-POR			Enable				Disable			
	ADR GPIO	Select between GPIO_B or GPIO_C.										
		GPIO B					GPIO C					
	Host Partition Reset ADR Enable	Enables/disables ADR on host partition reset.										
		Platform-POR			Enable				Disable			
Enable/Disable ADR Timer	Held-off for debug purposed only.											
	Platform-POR			Enable				Disable				
ADR timer expire time	Select proper ADR timer value.											
	Platform-POR	25 uS	50 uS	100 uS	0 uS							
ADR timer multiplier	Select proper ADR timer multiplier.											
	Platform-PDR	x1	x8	x24	x40	x56	x64	x72	x80	x88	x96	

4.5.2 Server ME Configuration

Configures ME Technology parameters.

Server ME Configuration	
Altitude	The altitude of the platform location above the sea level, expressed in meters. The hex number is decoded as 2's complement signed integer. Provided the 8000h value if the altitude is unknown. 8000
MCTP Bus Owner	MCTP bus owner location of PCIe: [15:8], [7:3] device, [2:0] function. If all zeros sending bus owner is disabled. 0

4.5.3 Server ME Debug Configuration

Server ME firmware debug parameters configuration.

Server ME Debug Configuration					
Server ME General Configuration	Server ME basic features configuration.				
	ME Intialization Complete Timeout	This option defines how long BIOS waits for ME to initialize. 2			
	Enable HSIO Messaging	Enable		Disable	
	DRAM Init Done Enable	Enable		Disable	
	DRAM Initialization Status	Auto - true status	0 - Success	1 - No Memory in Channels	2 - Memory Init Error
	Host Reset Warning	Enable		Disable	
	Pre-DramInit Done ME Reset	Enable		Disable	
	HMRFP0_LOCK Message	Enable		Disable	

Server ME General Configuration	HMRFP0_ENABLE Message	Enables/disables sending HMRFP0_ENABLE message to ME. Enable Disable
	END_OF_POST Message	Enables/disables sending END_OF_POST message to ME. Enable Disable
	REGION_SELECT Message	Enables/disables sending REGION_SELECT message to ME. Enable Disable
	CF9 global reset promotion	Enables/disables promoting CF9 reset to global. Enable Disable
	Global Reset Lock	Enables/disables locking the joint ME and host reset capability. Enable Disable
	HECI-1/2/3 Enable	Overrides HECU-1/2/3 status on PCI or let firmware decide based on ME type (auto). Auto Enable Disable
	IDEr Enable	Overrides IDEr status on PCI, or let firmware decide based on ME type (auto). Auto Enable Disable
	KT Enable	Overrides KT status on PCI, or let firmware decide based on ME type (auto). Auto Enable Disable
	HECI-1/2/3 Hide in ME	Enables sending request to ME to hide or disable HECI-1/2/3 on host PCI Off Hide Disable
	DOI3 Setting for HECI Disable	Setting this option disables setting DOI3 bit for all HECI devices. Enable Disable
	Break RTC Configuration	This is a test option which breaks RTC configuration. Enable Disable
	Core BIOS Done Message	Enables/disables Core BIOS Done message sent to ME. Enable Disable
	Delayed Authentication Mode (DAM)	Enables overriding the state of the Delayed Authentication Mode (DAM). Enable Disable
	Enable HECI Dump	Enables full HECI dumps in debug output. Enable Disable
NM Configuration	Boot Mode Override	Enables overriding the boot mode requested in NMFS. Enable Disable
	Cores Disable Override	Enables overriding the value of the number of cores to disable requested in NMFS register. Enable Disable
	Power Measurement Override	Overrides power measurement support status reported to ME. Enable Disable
	Hardware Change Override	Overrides hardware change detection status reported to ME. Enable Disable
	PTU Load Override	In MROM-less system force loading PTU regardless of ME request. Enable Disable

4.5.4 Runtime Error Logging

To view or change the runtime error log configuration.

Runtime Error Logging	
System Errors	System Error enable/disable setup options. Enable Disable

4.6 Socket Configuration

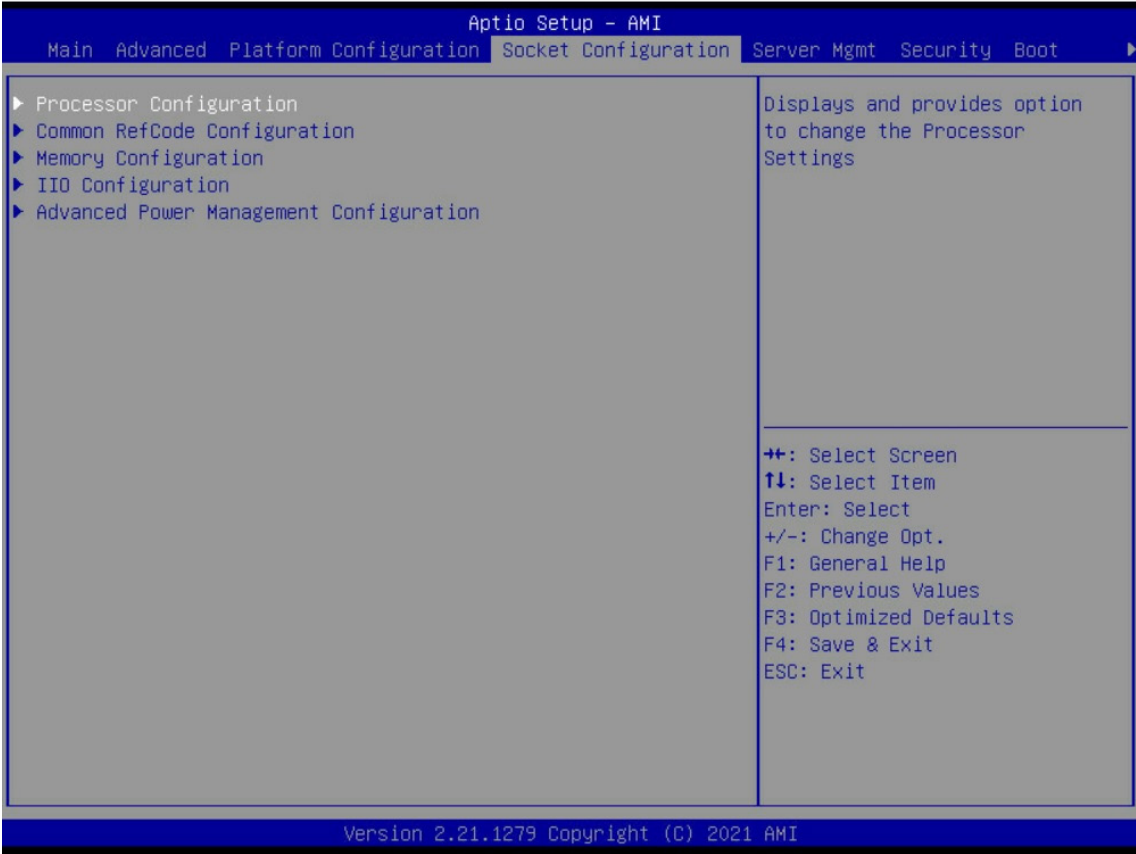

4.6.1 Processor Configuration

Displays and provides option to change the Processor Settings.

Processor Configuration		
Hyper- Threading [ALL]	Enables Hyper Threading (Software Method to enable/disable logical processor threads). Enable	Disable
Legacy Agent	Legacy PECCI agent in trust bit enable. Enable	Disable
SMBus Agent	SMBus PECCI agent in trust bit enable. Enable	Disable
IE Agent	IE PECCI agent in trust bit enable. Enable	Disable
Generic Agent	Generic PECCI agent in trust bit enable. Enable	Disable
eSPI Agent	ESPI PECCI agent in trust bit enable.- Enable	Disable
DBP-F	The DBP-F can be turned off by writing into the (MSR 792h [5:6] for CLX, and MSR 6Dh [2:3] for ICX). Enable	Disable
Lock Chipset	Locks or unlocks chipset. Enable	Disable
MSR Lock Control	Enable: MSR 3Ah and CSR 80h will be locked. Power good reset is needed to remove lock bits. Enable	Disable
PKG CST CONFIG CONTROL MSR Lock	Enable: MSR E2h will be locked. Power good reset is needed to remove lock bits. Enable	Disable
Total Memory Encryption (TME)	Enables/disables Total memory Encryption (TME). Enable	Disable

4.6.2 Common RefCode Configuration

Displays and provides option to change the Common RefCode Settings.

Common RefCode Configuration									
MMCFG Base	Select MMCFG base.								
	Auto	1G	1.5G	1.75G	2G	2.5G	3G		
MMCFG Size	Select MMCFG size.								
	Auto	64M	128M	256M	512M	1G	2G		
MMIO High Base	Select MMIO high base.								
	3584T	512G	1T	2T	4T	16T	24T	32T	40T
MMIO High Granularity Size	Select the allocation size used to assign mmioh resources. Total mmioh space can be up to 32 xgranularity. Per stack mmioh resource assignments are multiples of granularity where 1 unit per stack is the default allocation.								
	1G	4G	16G	64G	256G	1024G			
Isoc Mode	Enables/disables Isoc.								
	Auto	Enable				Disable			
Numa	Enables/disables Non uniform Memory Access (Numa).								
	Enable	Disable							
Virtual Numa	Divide physical NUMA nodes into evenly sized virtual NUMA nodes in ACPI table. This may improve Windows performance on CPUs with more than 64 logical processors.								
	Enable	Disable							

4.6.3 Memory Configuration

Displays and provides option to change Memory Settings.

Memory Configuration			
Enforce POR	<ul style="list-style-type: none"> Enable: Enforces Plan Of Record restrictions for DDR4 frequency and voltage programming. Disable: Disables this feature and user if able to run at higher frequencies, specified in DDR frequency limit field (limited by processor support). Auto: Sets it to the MRC default setting. 		
	POR	Disable	
Enforce Population POR	Enables Memory Population POR Enforcement. Selecting Enforce Validated Populations will only allow populations that have been validated.		
	Enforce Supported Population	Enforce Validated Populations	Disable Enforcement
PPR Type	Select Post Package Repair Type.		
	<ul style="list-style-type: none"> Auto: Sets it to the MRC default setting; current default is Soft PPR. 		
	Soft PPR	Hard PPR	PPR Disable
PPR Error Injection test	Enables/disables support for c-script err inj test.		
	Enable	Disable	
Memory Frequency	Maximum Memory Frequency Selections in Mhz. If Enforce POR is disabled, user will be able to run at higher frequency than the memory support (limited by processor support). Do not select reserved.		
	Auto	1200~4800-OvrClk	
MRC Promote Warnings	Determines if warnings are promoted to system level.		
	Enable	Disable	
Halt on mem Training Error	Halts on mem Training Error disable/enable.		
	Enable	Disable	
Rank Switch Configuration	TA Floor enforces t_rrdr, t_rrdd minimum of 3; Rcvn Ave attempts to match Rcvn logic delay across ranks.		
	TA Floor	Rcvn Ave	Reserved
Enable ADR	Enables the detecting and enabling of ADR. This is not available if eADR is enabled since eADR requires ADR to be enabled.		
	Enable	Disable	
Legacy ADR Mode	Enables/disables Legacy ADR mode. This is not available if eADR is enabled since eADR requires this mode to be enabled.		
	Enable	Disable	

Minimum System Memory Size	Minimum memory size assigned as system memory when only JEDEC NVDIMMs are present.			
	2GB	4GB	6GB	8GB
NVDIMM Energy Policy	Sets the energy policy for NVDIMMs			
	Device-Managed		Host-Managed	
ADR Data Save Mode	DATA Save mode for ADR. Batterybacked or Type 01 NVDIMM.			
	NVDIMMs		Batterybacked DIMMs	Disable
Erase-Arm NVDIMMs	Enables/disables Erasing and Arming NVDIMMs.			
	Enable		Disable	
Restore NVDIMMs	Enables/disables Automatic restoring of NVDIMMs.			
	Enable		Disable	
Interleave NVDIMMs	Controls if NVDIMMs are interleaved together or not.			
	Enable		Disable	
Memory Topology	Displays memory opology with DIMM population information.			

4.6.4 IIO Configuration

Displays and provides option to change IIO Settings.

IIO Configuration						
Socket0/1 Configuration	IOU0/1/2/3/4 (IIO PCIe Port 1/2/3/4/5)	Select PCIe port Bifurcation for selected slot (s).				
		Auto	x4x4x4x4	x4x4x8		
		x8x4x4	x8x8	x16		
	Sck0 RP Correctable Err	Applies to root ports only. Enable interrupt on a non-fatal error.				
		Yes		No		
	Sck0 RP Fatal Uncorrectable Err	Applies to root ports only. Enable MSI/INTx interrupt on fatal errors.				
		Yes		No		
	Port 0/DMI	Settings related to PCI Express Ports (0/1A/1B/1C/1D/2A/2B/2C/2D/3A/3B/3C/3D/4A/4B/4C/4D/5A/5B/5C/5D)				
	Port 1A/2A/4A/5A	PCI-E Port	In auto mode, the BIOS will remove the EXP port if there is no device or errors on that device and the device is not HP capable. Enable/disable is used to enable/disable and expose/hide its CFG space.			
			Auto	Enable	Disable	
PCI-E Port Link Disable		This option disables the link so that the no training occurs but the CFG space is still active.				
	Yes		No			
Link Speed	Choose link speed for this PCIe port.					
	Auto	Gen 1 (2.5 GT/s)	Gen 2 (5 GT/s)	Gen 3 (8 GT/s)	Gen 4 (16GT/s)	
IOAT Configuration	Sck0/1 IOAT Config	DNA	Select Dma enable/disable for each CB device.			
			Yes		No	
	Disable TPH	No snoop	Enables/disables for each CB device.			
			Yes		No	
		TLP Processing Hint disable.				
	Yes		No			
Prioritize TPH	Prioritize TPH.		Disable			
	Enable		Disable			
Relaxed Ordering	Enables/disables Relaxed Ordering.					
	Yes		No			
Intel VT for Directed I/O (VT-d)	Intel VT for Directed I/O	Enables/disables VT-d Interrupt Remapping support.				
		Enable		Disable		
DMA Control Opt-In Flag	DMA Control Opt-In Flag	Enables/disables DMA_CTRL_PLATFORM_OPT_IN_FLAG in DMAR table in ACPI. Not compatible with Direct Device Assignment (DDA).				
		Enable		Disable		

Intel VT for Directed I/O (VT-d)	Interrupt Remapping	Enables/disables Interrupt Remapping support.		
		Auto	Enable	Disable
	X2APIC Opt Out	Enables/disables X2APIC_OPT_OUT bit.		
		Enable	Disable	
	Pre-boot DM Protection	Enables DMA Protection in Pre-boot environment (If DMAR table is installed in DXE and VTD_INFO is installed in PEI.)		
		Enable	Disable	
Intel VMD technology	Intel VMD for Volume Management Device on Socket 0/1	Enable/disable VMD	Enables/disables VMD in this stack.	
		Enable	Disable	
Intel AIC Retimer/AIC SSD Technology (non-VMD)	Intel AIC Retimer/AIC SSD on Socket 0/1	Anonce Intel AIC Retimer/AIC SSD HW at Stack1(Port 1A-1D). Override IOU0 bifurcation if required.		
		Enable	Disable	
Detected PCIe retimers	Socket 0/1 retimers configuration.			
PCIe Low Latency Retimers	Enables/disables PCIe low latency retimers.			
	Yes	No		
Skip PCIe retimers detection	Skip PCIe retimers detection to speedup the boot. Retimers are preent only in specific HW configurations.			
	Yes	No		

4.6.5 Advanced Power Management Configuration

Displays and provides to change the Power Management settings.

Advanced Power Management Configuration				
CPU P State Control	P State Control Configuration Sun Menu, include Turbo, XE and etc.			
	Uncore Freq Scaling	If disabled, user can input Uncore Frequency.		
		Enable	Disable	
	AVX Licence Pre-Grant Override	If disabled, user can input Uncore Frequency.		
		Enable	Disable	
	SpeedStep (Pstates)	Enables/disables EIST (P-States).		
		Enable	Disable	
	AVX P1	AVX P1 level selection.		
		Normal	Level 1	Level 2
	Dynamic SST-PP	Supports Dynamic SST-PP Select. NOTE: Disable: Static SST-PP can be displayed.		
		Enable	Disable	
	Intel SST-PP	Intel SST-PP Select allows user to choose from up to two additional base frequency conditions.		
		Base	Config 3	Config 4
	Activate SST-BF	This option allows SST-BF to be enabled.		
		Enable	Disable	
EIST PSD Function	Choose HW_ALL/SW_ALL in _PSD return.			
	HW_ALL	SW_ALL		
Boot performance mode	Select the performance state that the BIOS will set before OS hand off.			
	Max Performance	Max Efficient	Set by Intel Node Manager	
Energy Efficient Turbo	Energy Efficient Turbo Disable, MSR 0x1FC [19]			
	Enable	Disable		
Turbo Mode	Enables/disables processor Turbo Mode (requires EMTTM enabled too.)			
	Enable	Disable		
CPU Flex Ratio Override	Enables/disabled CPU Flex Ratio Programming.			
	Enable	Disable		
GPSS timer	P-state change hysteresis time window.			
	0 us	50 us	500 us	

Hardware PM State Control	Hardware P-State setting.			
	Hardware P-States	<ul style="list-style-type: none"> Disable: Hardware chooses a P-state based on OS Request (Legacy P-States). Native Mode: Hardware chooses a P-state based on OS guidance. Out of Band Mode: Hardware autonomously chooses a P-state (no OS guidance). 		
		Native Mode	Out of Band Mode	Native Mode with No Legacy Support
	HardwarePM Interrupt	Enables/disables Hardware PM Interrupt.		Disable
	EPP Enable	When disabled, HW masks EPP in CPUID [6],10 and uses EPB for EPP.		
	APS rocketing	Enables/disables the rocketing mechanism in the HWP p-state selection pcode algorithm. Rocketing enables the core ratio to jump to max turbo instantaneously as opposed to a smooth ramp up.		
		Enable		Disable
Scalability	Enable/disable Core Performance to Frequency Scalability Based Optimizations in the CPU.			
	Enable		Disable	
Native ASPN	<ul style="list-style-type: none"> Enable: OS Controlled ASPM. Disable: ASPM off. Auto: BIOS Controlled ASPM. 			
	Auto	Enable	Disable	
CPU C State Control	CPU C State setting.			
	Enable Monitor MWAIT	Allows Monitor and MWAIT instructions.		
	CPU C1 auto demotion	Allows CPU to automatically demote to C1. Takes effect after reboot.		
		Enable		Disable
	CPU C1 auto undemotion	Allows CPU to automatically undemote to C1. Takes effect after reboot.		
		Enable		Disable
	CPU C6 report	Enables/disables CPU C6(ACPI C3) report to OS.		
Auto		Enable	Disable	
Enhanced Halt State (C1E)	Core C1E auto promotion control. Takes effect after reboot.		Disable	
OS ACPI Cx	Report CC3/CC6 to OS ACPI C2 or ACPI C3.			
	ACPI C2		ACPI C3	
Package C State Control	Package C State setting.			
	Package C State	Package C State limit.		
		Auto	C0/C1 state	C2 state
	Register Access Low Latency Mode	Enables lower latency mode for register accesses. NOTE: Enabling this mode will prevent PkgC6 as register access fabric is prevented from going into idle.		
		Enable		Disable
	C2C3TT	Default = 0, means [Auto]. C2 to C3 Translation Timer, PPDN_INIT = 1:10:1:74 Bit [11:0].		
0				
Dynamic L1	PCU_MISC_CONFIG Bit [21] = dynamic L1 enable.			
	Enable		Disable	
PKG C-state Lat. Neg.	MSR 1FCh Bit [30] = PCH_NEG_DISABLE.			
	Enable		Disable	

Package C State Control	LTR IIO Input	MSR 1FCh Bit [29] = LTR_IIO_DISABLE. Disable = Ignore IIO LTR input.			
		Take IIO LTR input		Ignore IIO LTR input	
	Latency Tolerance Requirement (LTR)	Program PCIE_IL TR_OVRD 1:30:1:0xFC Sub Menu.			
		PCIe LTR Override Control	Allows manual overrides for PCIE_IL TR_IVRD.		
			Enable	Disable	
CPU Thermal Management	Enable PKGC_SA_PS_CRITERIA	Program WRITE_PKGC_SA_PS_CRITERIA Sub Menu.			
		Auto	Enable	Disable	
	PkgC SA PS Criteria Power Management Control	Program WRITE_PKGC_SA_PS_CRITERIA Sub Menu.			
		MDLL Off	Enable to shut down MDLL during SR.		
		Auto	Enable	Disable	
CPU Thermal Management	PkGc Interrupt Response Time	Programmable Package C-state interrupt response time setup control.			
		VALID	Enable	Disable	
	CPU T State Control	CPU Thermal Related setting.			
		Software Controlled T-States	Enables/disables Software Controlled T-States.		
			Enable	Disable	
	PROCHOT Modes	When a processor thermal sensor trips (either core), the PROCHOT# will be driven. If bi-directionis enabled, external agents can drive PROCHOT# to throttle the processor.			
		Input-only	Both Input and Output	Output-only	Disable
CPU Thermal Management	Thermal Monitor	Enables/disables Thermal Monitor			
		Enable	Disable		
	Therm-Monitor-Status Filter	Enables Filter based therm_monitor_status(IA32_THERMAL_STATUS[0]) reporting.			
		Enable	Disable		
	PROCHOT RATIO	Controls the CPU response to an inbound platform assertion of xxPROCHOT# by capping to the programmed ratio. Default value 0 will allow ME to control this value. If ME does not set ratio, default 0 equates to Pn. A non-zero value will override ME setting. The min allowed ratio is defined by PLATFORM_INFO[MIN_OPERATING_RATIO].			
		0	Min=0, Max=57		
	TCC Activation Offset	Offset from factory set TCC activation temperature at which the Thermal Control Circuit must be activated.			
	0	Min=0, Max=58			
CPU- Advanced PM Tuning	Setting Energy Per Bias Pwr_Ctl, PP0 Current SWL TD, SAPM etc.				
	Energy Perf Bias	Energy Perf BIAS Sub Menu.			
		Power Performance Tuning	OS Controls EPB	BIOS Controls EPB	PECI Controls EPB
		PECI PCS EPB	Controls whether PECI has control over EPB		
			OS controls EPB	PECI controls EPB using PCS.	
		Dynamic Loadline Switch	Dynamic Loadline Switch control. MSR 0x1FC[Bit24].		
	Enable	Disable			
Workload Configuration	This allows optimization for the workload characterization. The three options for selection.				
	Balanced	I/O sensitive			
Averaging Time Window	This is used to control the effective window of the average for C0 and P0 time.				
	1A				

CPU- Advanced PM Tuning	Energy Perf Bias	P0 Total Time Threshold Low	The HW switching mechanism DISABLES the performance setting (0) when the total P0 time is less than this threshold.	
		P0 Total Time Threshold High	The HW switching mechanism DISABLES the performance setting (0) when the total P0 time is greater than this threshold.	
	SAPM Control	Energy Perf BIAS Sub Menu.		
		Enable	Disable	
EET Mode	Coarse Grained Mode decides whether to grant user request turbo or P1. Fine Grained Mode decides how much turbo to be granted. More helpful with Scalability Enabled.			
	Coarse Grained Mode	Fine Grained Mode		

4.7 Server Mangement

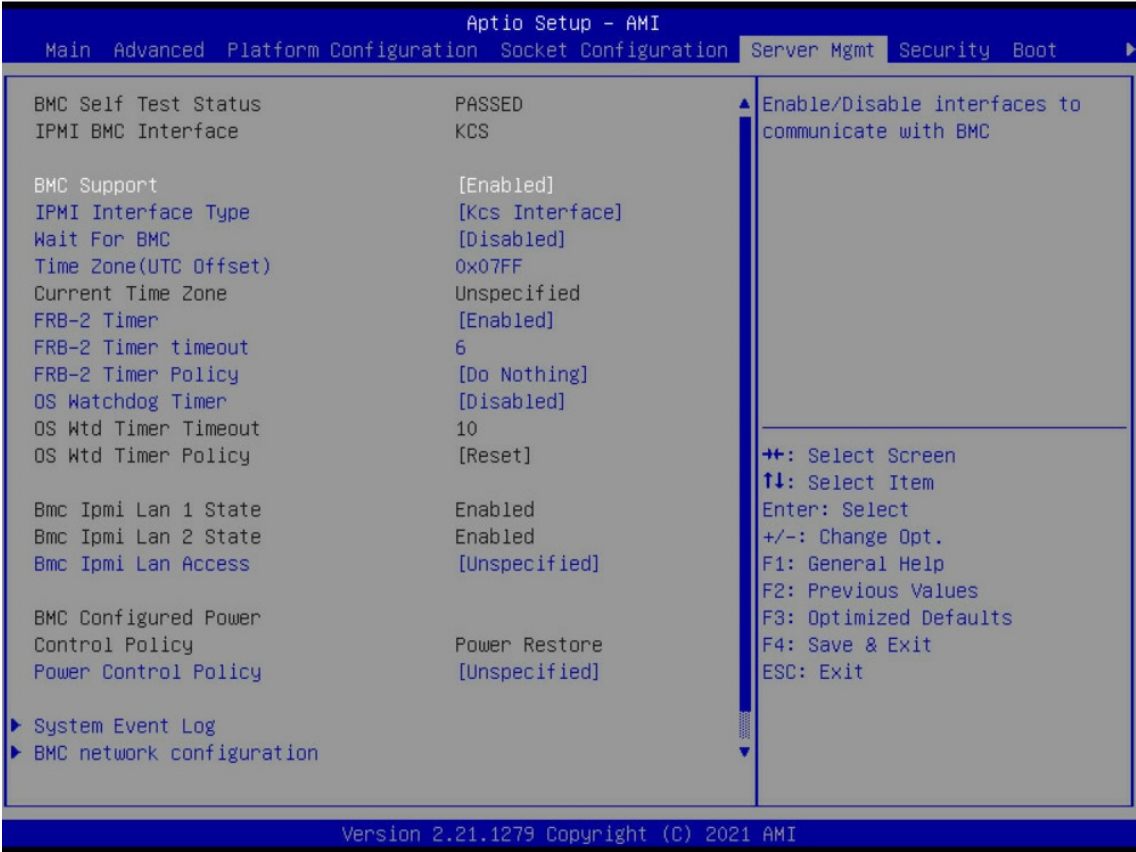

4.7.1 Processor Configuration

Displays and provides option to change the Processor Settings.

Processor Configuration	
BMC Support	Enables/disables interfaces to communicate with BMC. Enable Disable
IPMI Interface Type	Type of Interface to communicate BMC from Host. Kcs Interface Bt Interface
Wait for BMC	Wait for BMC response for specified time out. In PILOTII, BMC starts at the same time when BIOS starts during AS power ON. It takes around 30 seconds to initialize Host to BMC interfaces. Enable Disable
Time Zone(UTC Offset)	Enter UTC Offset in hours. i.e. from -24:00 to +24:00. These values will be converted into minutes and programmed to BMC. Enter 0x07FF to consider BIOS time as local time. 0x07FF
FRB-2 Timer	Enables/disables FRB-2 timer (POST timer). Enable Disable
FRB-2 Timer timeout	Enter value between 1 to 30 minutes for FRB-2 Timer Expiration. 6 1-30
FRB-2 Timer Policy	Configures how the system should respond if the FRB-2 Timer expires. Not available is FRB-2 Timer is disabled. Do nothing Reset Power Down Power Cycle
OS Watchdog Timer	If enabled, starts a BIOS timer which can only be shut off by Management Software after the OS loads. Helps determine that the OS successfully loaded or follows the OS Boot Watchdog Timer policy. Enable Disable
BMC IPMI LAN Access	Enables/disables BMC IPMI LAN. Enable Disable Unspecified
Power Control Policy	Configures how the system should respond if AC power is lost. Reset not required as selected power policy will be set in BMC when policy is saved. Do Not Power Up Last Power State Power Restore Unspecified

4.7.2 System Event Log

Configures SEL event log.

System Event Log			
SEL Components	Change this to enable or disable event logging error/progress codes during boot.		
	Enable		Disable
Erase SEL	Choose options for erasing SEL.		
	Yes, on next reset	Yes, on every reset	No
When SEL is Full	Choose options for reactions to full SEL.		
	Do Nothing	Erase Immediately	Delete oldest Record
Log EFI Status Codes	Disables the logging of EFI Status Codes or log only error code or only progress code or both.		
	Error code	Progress code	Both

4.7.3 BMC Network Configuration

Configures BMC network parameters.

BMC Network Configuration			
Configuration Address source	Select to configure LAN channel parameters statically or dynamically (by BIOS or BMC). Unspecified option will not modify any BMC network parameters during BIOS phase.		
	Enable		Disable
IPv6 Support	Enables/disables LAN1 IPv6 Support		
	Unspecified	Static	Dynamic BMC DHCP
Configuration Router LAN1/2 Address	Select to configure LAN channel parameters statically or dynamically (by BIOS or BMC). Unspecified option will not modify any BMC network parameters during BIOS phase.		
	Unspecified	Static	Dynamic BMC DHCP

4.8 Security

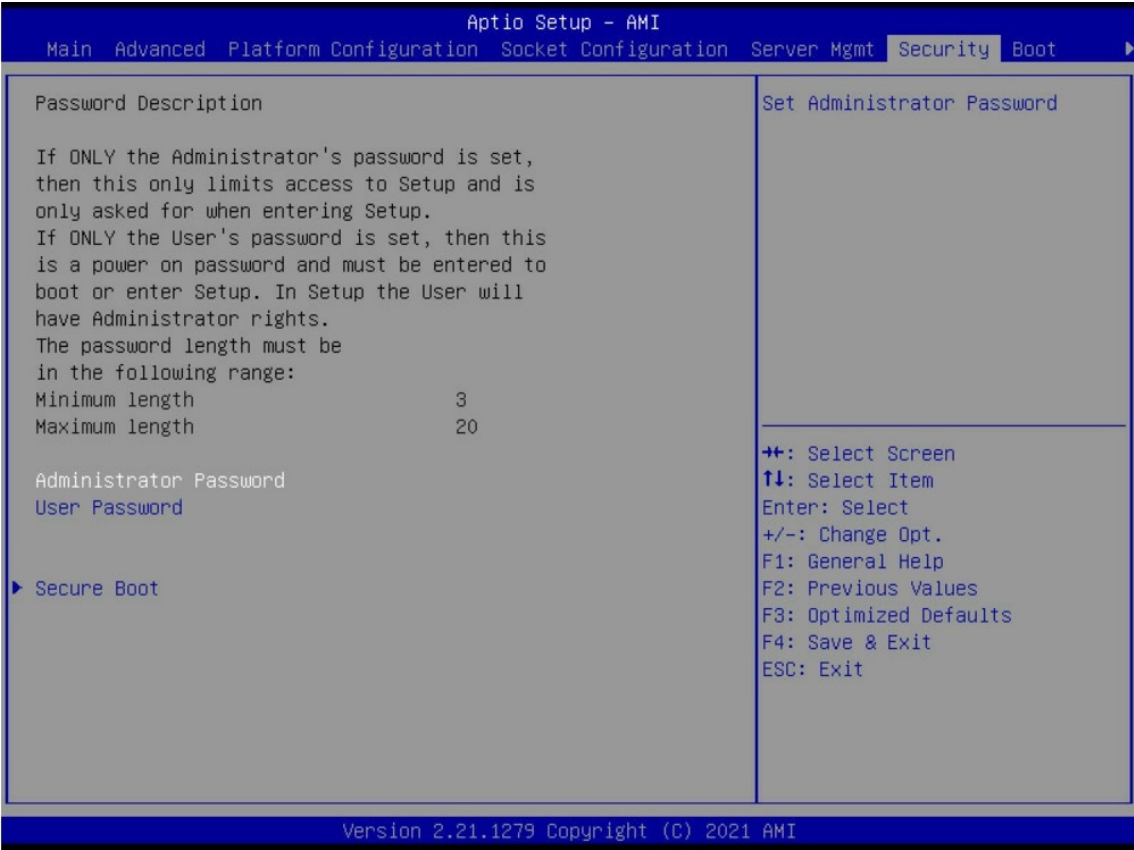

Security		
Administrator Password	Set administer password.	
Set User Password	Create new password.	
Secure Boot	Secure boot configuration.	
	Secure Boot	Enable Disable
	Secure Boot Mode	Secure Boot mode options: Standard or Custom. In Custom mode, Secure Boot Policy variables can be configured by a physically presen user without full authentication. Standard Custom

4.9 Boot

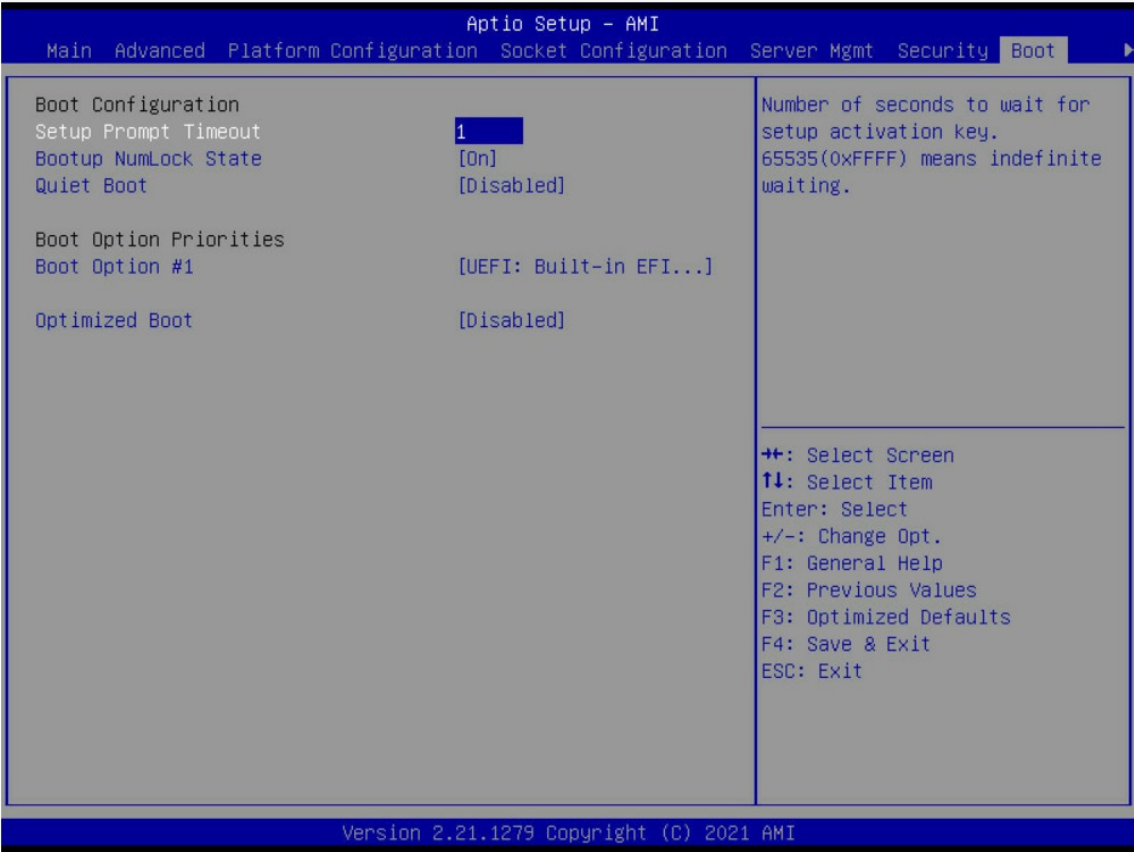

Boot	
Set Prompt Timeout	Number of seconds to wait for setup activation key. 65565 (0xFFFF) means indefinite waiting. On
Bootup Numlock State	Select the keyboard Numlock state. On Off
Quiet Boot	Enables/disables Quiet Boot option. Enable Disable
Boot Option #1	Sets the system boot order. UEFI: Built-in EFI Shell Disable
Optimized Boot	Enables/disables Optimized Boot. Enabling Optimized Boot will disable Csm support and disable connecting Network devices to decrease boot time. While disabling Optimized Boot, make sure to restore Csm Support option to previous value before enabling Optimized Boot. Enable Disable

4.10 Exit

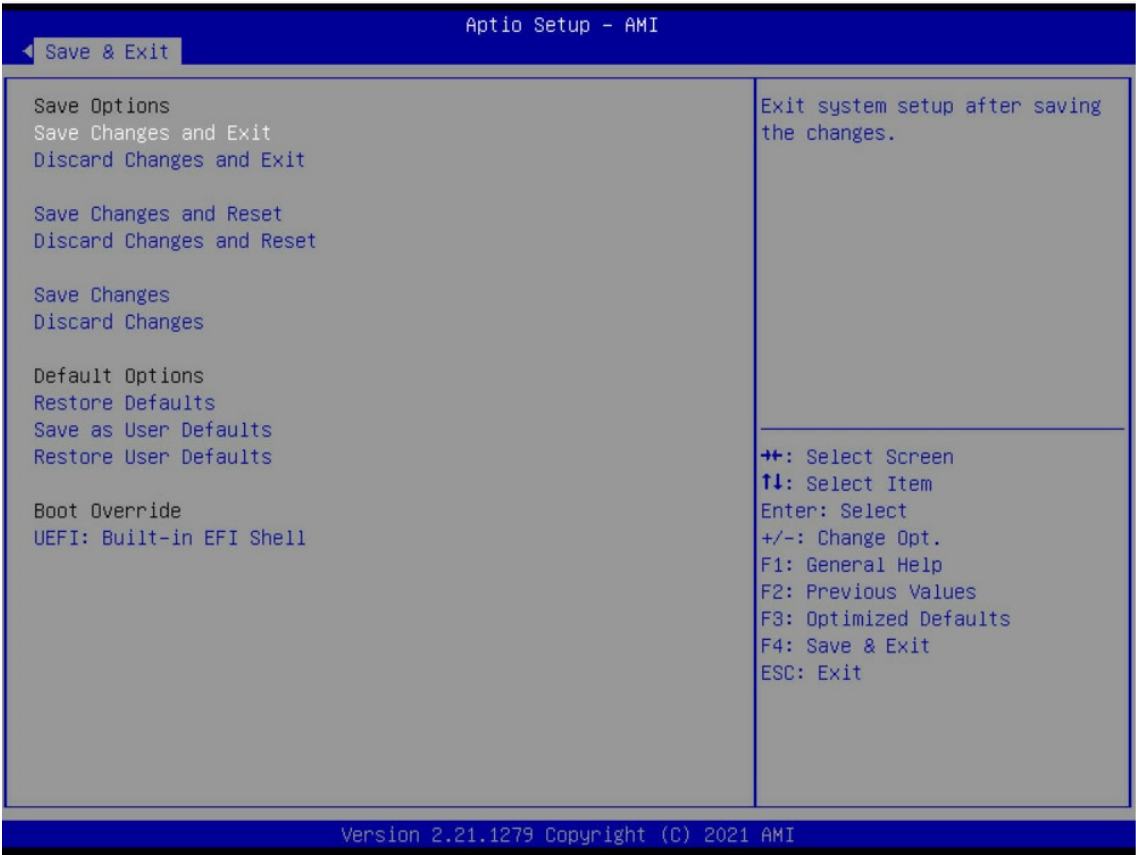

Exit	
Save Change and Exit	Exit system setup after saving the changes.
Discard Changes and Exit	Exit system setup without saving any changes.
Save Changes and Reset	Reset the system after saving the changes.
Discard Changes and Reset	Reset system setup without saving any changes.
Save Changes	Save changes done so far to any of the setup options.
Discard Changes	Discard changes done so far to any of the setup options
Restore Defaults	Restore/load default values for all the setup options.
Save as User Defaults	Save the changes done so far as user defaults.
Restore User Ddefaults	Restore the user defaults to all the setup options.

4.11 BIOS Update Process

This is the manual for updating BIOS on **Tucana** system. Please check current system BIOS version is **Tuct0010** or later. Here are the update procedures.

EFI:

1. Copy Tuct0010.bin to EFI folder
2. Copy EFI folder to USB stick or HDD
3. **Boot into internal** shell enters the usb EFI folder and executes the below command **Bios.nsh**
4. If the firmware update is complete, perform an AC power cycle.

Linux:

1. Copy Tuct0010.bin to AfuLnx64 folder
2. Copy AfuLnx64 folder to USB stick or HDD
3. Enter to AfuLnx64 folder and execute the below command./flash.sh
4. Reboot if complete the updated

**NOTE**

AFU FLASH Update may report change in ROM Layout. You can "F" to force the FLASH.

**NOTE**

Please refer to "**Bios Update Process.doc**" in bios release zip file for details.

Chapter 5. BMC Configuration Settings

5.1 Login



NOTE

For further details about the BMC, please refer to Tucana BMC Manual for reference. AIC® website link: <https://www.aicpc.com/en/productdetail/51337>.

The BMC default IP source is DHCP. The IP address can be configured in H2O IPMI configuration as demonstrated by the example below.

Step 1 Open the browser and then type in the BMC IP address.
IP address example: 192.168.22.108

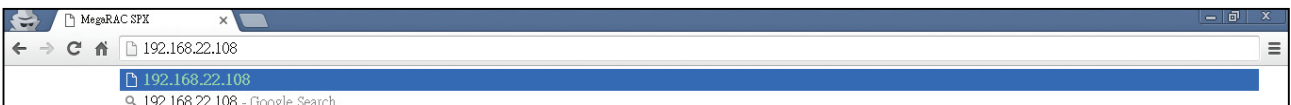

Step 2 Use the default user name and password for first-time BMC WEB GUI login.

Field:	Default
UserName:	admin
Password:	admin

AIC

Username

Password

US - English

Remember Username

Sign me in

[I forgot my password](#)



NOTE

The default user name and password are in lower-case characters. Users who login with the root user name and password will have full administrative power. The root password can be changed after login.

5.2 Web GUI

5.2.1 Menu Bar

The menu bar displays the following.

Firmware Information will be displayed with the latest version, date and time details. Power Control Status will be displayed as Host Online. To change the Power Control Status, click [Host Online](#) link.

- Dashboard
- Sensor
- System Inventory
- FRU Information
- Logs & Report
- Settings
- Remote Control
- Image Redirection
- Power Control
- Maintenance
- Sign out

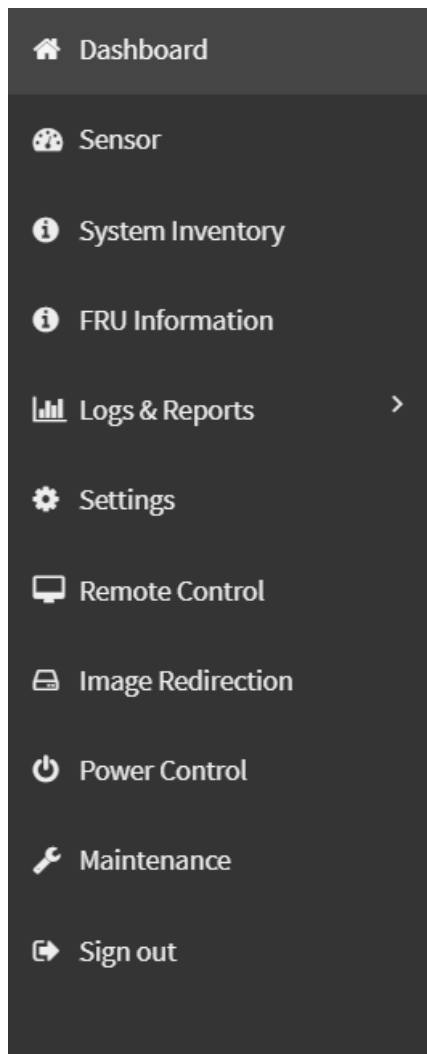

5.2.2 Dashboard

The Dashboard page gives the overall information about the status of a device. To open the Dashboard page, click **Dashboard** from the menu bar. A sample screenshot of the Dashboard page is shown below.

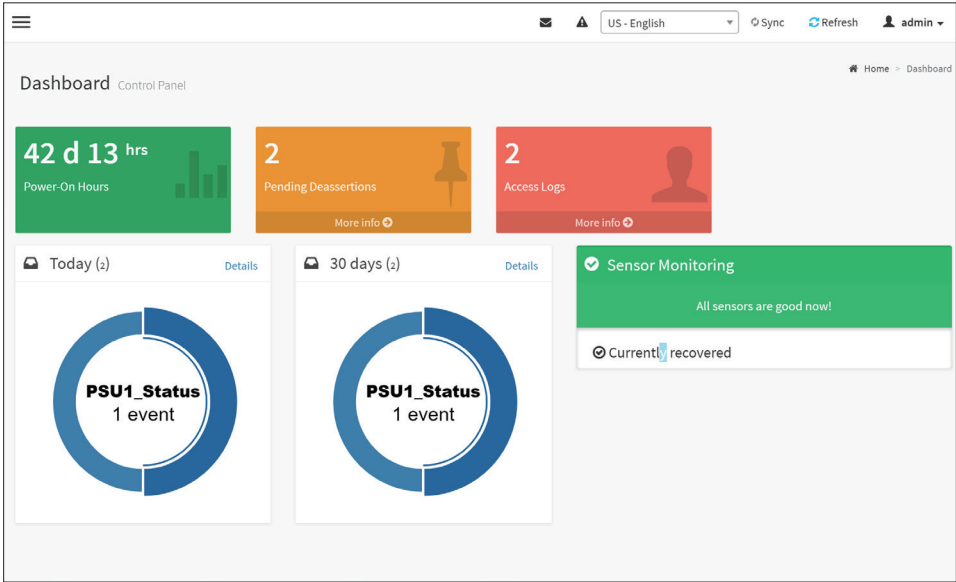

A brief description of the Dashboard page is given below.

- Language Selection
- BMC Power-On Hours
- Pending Deassertions
- Access Logs
- Today & 30 Days (Event Logs)
- Sensor Monitoring

5.2.3 Sensor

The Sensor Reading page displays all the sensor related information.

To open the Sensor Reading page, click [Sensor](#) from the menu. Click on any sensor to show more information about that particular sensor, including thresholds and a graphical representation of all associated events. A screenshot of Sensor Reading page is given below.

Sensor Name	State
PSU1_Status	No state defined
PSU2_Status	Presence Detected
Watchdog_BMC	No state defined

Sensor Name	Reading	Behavior
+1.05V_PCH	1.05 Volts	
+12V	12.12 Volts	

5.2.4 System Inventory

System Inventory page displays inventory information of host machine.

This page shows System, Processor, Memory Controller, Base Board, Power, Thermal, PCIE Devices, PCIE Function and Storage of host machine.

Click the tabs in the page to view details of each device. A screenshot of System Inventory page is given below.

Name	Description	Model	Indicator/LED	Manufacturer	PowerState	SerialNumber	PartNumber	SystemType	AssetTag	BiosVersion	UUID	State
System	System Self	SB101-TU	Off	AIC	Off	515-22061800100006	XP1-S101TU02X02	Physical	Free form asset tag	Tuca0010	24D4DFD8-1DD2-1000-0387-0015B2AD9455	Enabled

5.2.5 FRU Information

FRU Information page displays the BMC’s FRU device information. FRU page shows information like Basic Information, Chassis Information, Board Information and Product Information of the FRU device.

To open the FRU Information page, click [FRU Information](#) from the menu bar. Select a FRU Device ID from the FRU Information section to view the details of the selected device. A screenshot of FRU Information page is given below.

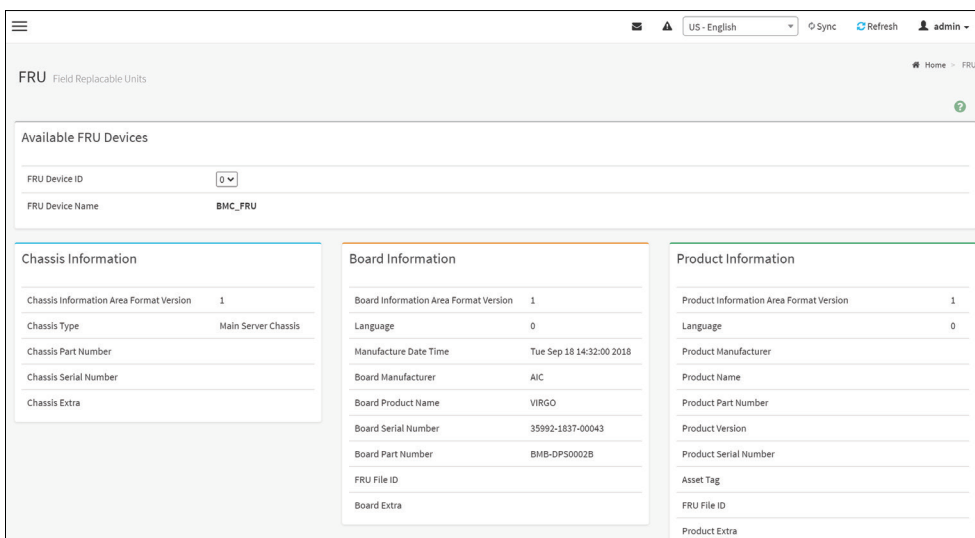

5.2.6 Log & Reports

The Logs & Reports page displays the following information.

- IPMI Event Log
- System Log
- Audit Log
- Video Log

A screenshot displaying the menu items under Logs & Reports is shown below.

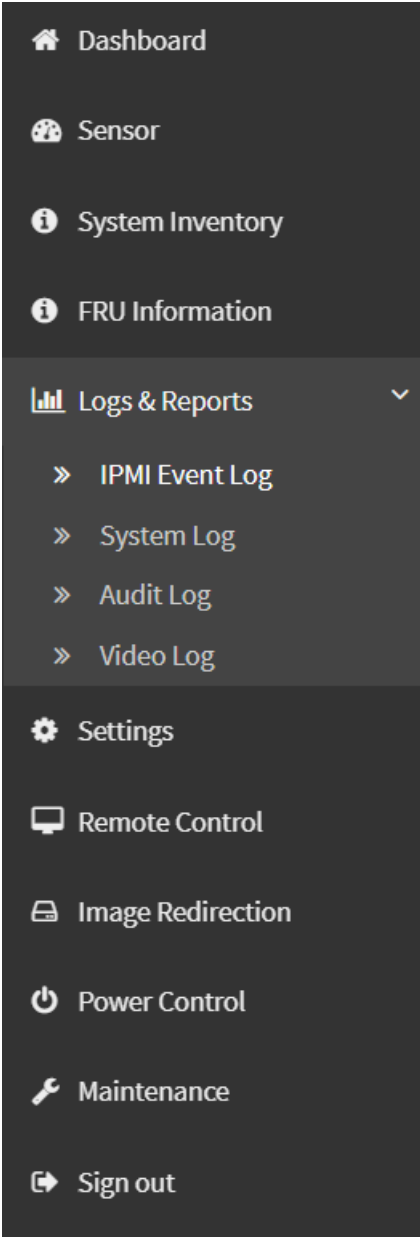

5.2.7 Settings

This group of pages allows you to access various configuration settings. A screenshot of Configuration Group menu is shown below.

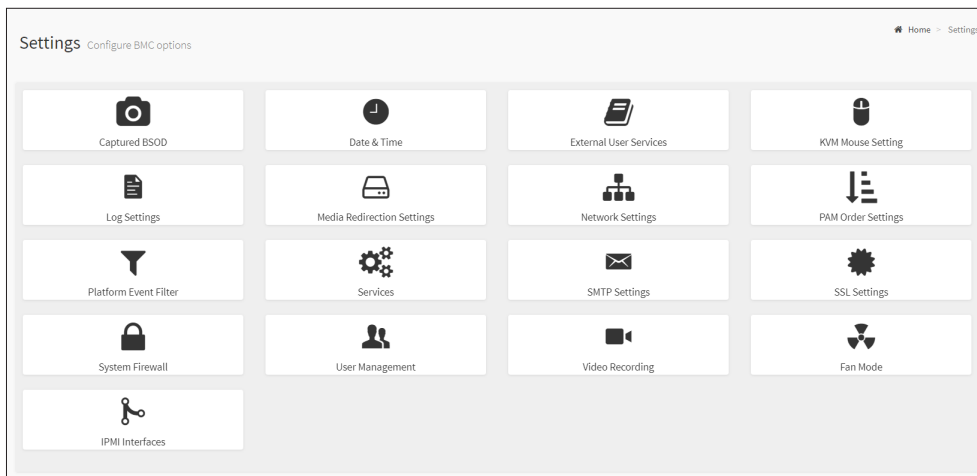

Configuration Group Menu

- Captured BSOD
- Date and Time
- External User services
- KVM Mouse Settings
- Log Settings
- Media Redirection Settings
- Network Settings
- PAM Order Settings
- Platform Event Filter
- Service
- SMTP Settings
- SSL Settings
- System Firewall
- User Management
- Video Recording
- Fan Mode
- IPMI Interfaces

5.2.8 Remote Control

The Remote Control page consists of the following options. A sample screenshot is displayed below.

- Launch H5Viewer
- Launch JViewer
- Launch Serial Over LAN



Launch H5Viewer

The system and browser requirements for Remote Control are given below.

System Requirements

- Client machine with 8GB RAM.
- If the client machine has 4GB RAM or lower, there will be lag in Video/Keyboard/Mouse/Media redirection functionality.

Supported Browsers

- Chrome latest version
- Firefox (with limited support)
- Microsoft Chromium-based Edge
- Safari (On Mac only)



NOTE

It is advisable to use Chrome or IE for H5Viewer, since Firefox has its own memory limitations.

In Microsoft Windows operating systems, IPv4 addresses are valid location identifiers in Uniform Naming Convention (UNC) path names. However, the colon ':' is an illegal character in a UNC path name. Thus, the use of IPv6 addresses is also illegal in UNC names.

For this reason, in IE browser the IPV6 address should be given in "Literal IPv6 addresses in UNC path names" format.

Example:

For web, 2001-db8-85a3-8d3-1319-8a2e-370-7348.ipv6-literal.net:85
Where IP is 2001:db8:85a3:8d3:1319:8a2e:370:7348 and port is 85.

To open Remote Control page, click [Remote Control](#) from the menu bar.

A detailed description of the menu items are given below.

Open the Remote Control page, click [Launch H5Viewer](#). A sample screenshot of the Remote KVM page is shown below.

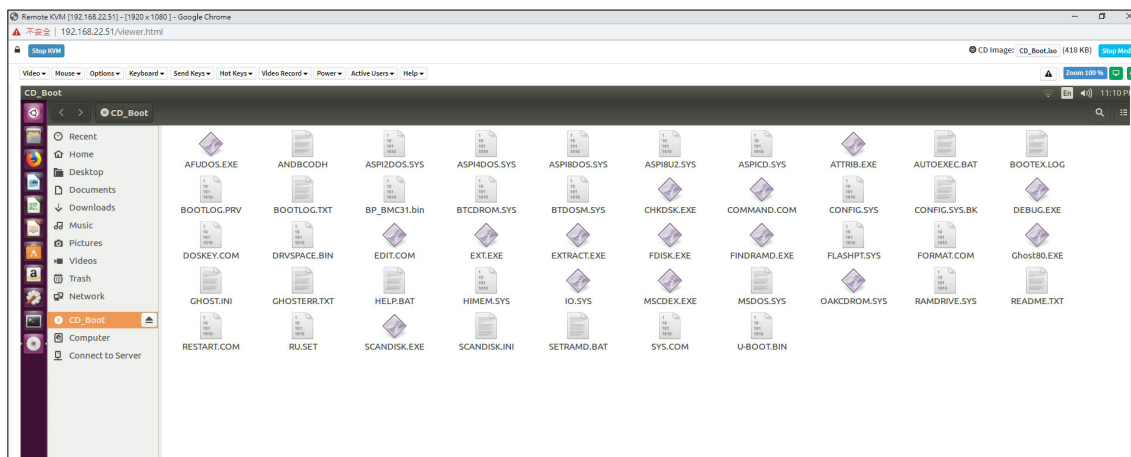

Procedure To Start KVM

1. Click [Launch H5Viewer](#) to open the Remote Control KVM page. A sample screenshot of the Remote KVM page is shown below.

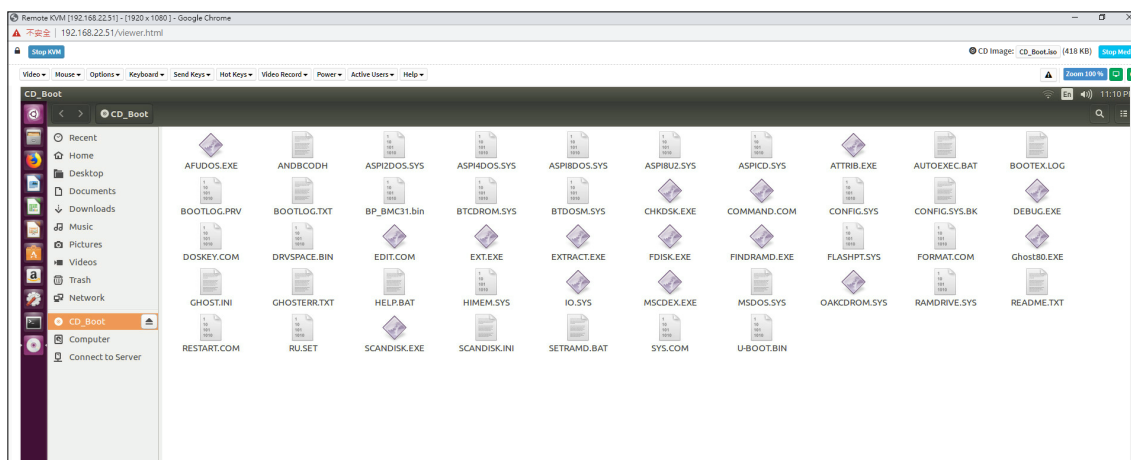

2. To stop the H5Viewer video redirection, click [Stop KVM](#).

Launch JViewer

This is an OS independent plug-in which can be used in Windows as well as Linux with the help of JRE. JRE should be installed in the client's system.

Activate Serial Over LAN

Activate Serial Over LAN.

Serial Over LAN (SOL) is a mechanism that enables the input and output of the serial port for a managed system to be redirected over IP; In this feature, Serial data is transmitted to HTML5 Web UI through websocket.

5.2.9 Images Redirection

This page is used to configure the images into BMC for redirection. This can be done either by uploading an image into BMC say, Local Media or by mounting the image from the remote system, Remote Media.

To open Images Redirection page, click [Images Redirection](#) from the menu bar. A sample screenshot of Images Redirection page is shown below.

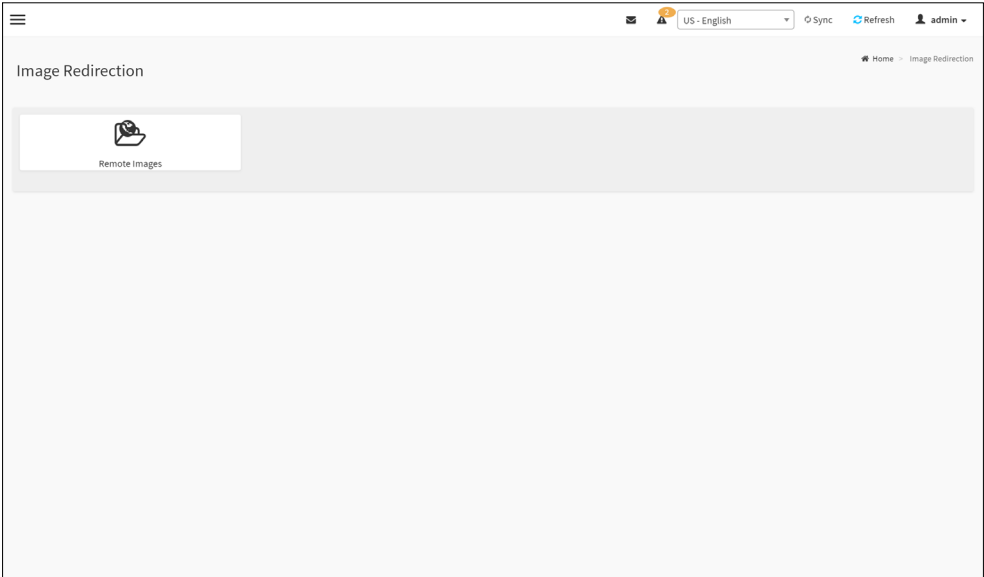

The fields of Images Redirection page are explained below.

- Remote Images

The displayed table shows configured images on BMC. You can configure images of the remote media server.

Media Type	Media instance	Image Name	Redirection Status	Connected Server Session Index
CD/DVD	0	cdiso2.iso	N/A	
CD/DVD	1	cdiso2.iso	N/A	
CD/DVD	2	cdiso2.iso	N/A	
CD/DVD	3	cdiso2.iso	N/A	
Hard disk	0	rom.ima	N/A	
Hard disk	1	rom.ima	N/A	
Hard disk	2	rom.ima	N/A	
Hard disk	3	rom.ima	N/A	

5.2.10 Power Control

This page allows you to view and control the power of your server.

To open Power Control, click [Power Control](#) from the menu bar. A sample screenshot of Power Control is shown below.

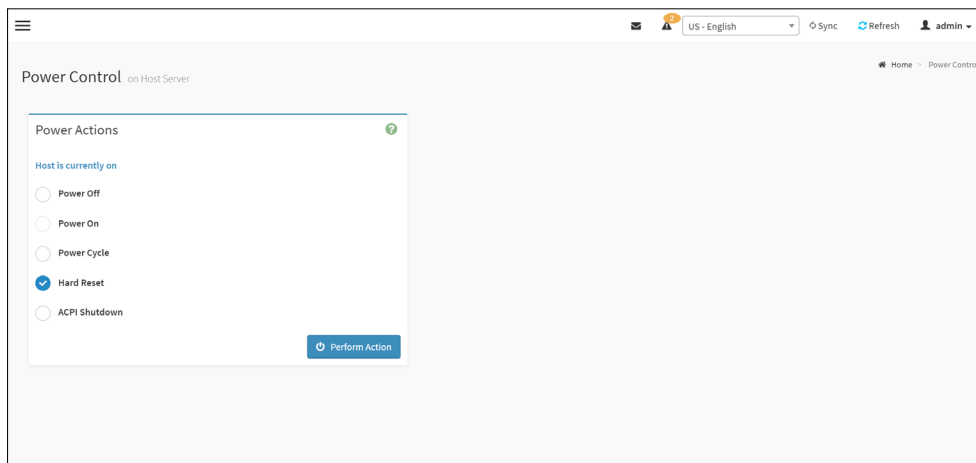

The various options of Power Control are given below.

Power Off: To immediately power off the server.

Power On: To power on the server.

Power Cycle: This option will first power off, and then reboot the system (cold boot).

Hard Reset: This option will reboot the system without powering off (warm boot).

ACPI Shutdown: This option to initiate operating system shutdown prior to the shutdown.

Perform Action: Click this option to perform the selected operation.

Procedure

Select an action and click [Perform Action](#) to proceed with the selected action.



NOTE

During Execution you will be asked to confirm your choice. Upon confirmation, you will be informed about the status after few minutes.

5.2.11 Maintenance Group

This group of pages allows you to do maintenance tasks on the device. The menu contains the following items:

- Backup Configuration
- BMC Recovery
- Firmware Image Location
- Firmware Information
- Firmware Update
- Preserve Configuration
- Restore Configuration
- Restore Factory Defaults
- System Administrator
- POST Code
- BMC Reset

A sample screenshot of Maintenance page is displayed below.

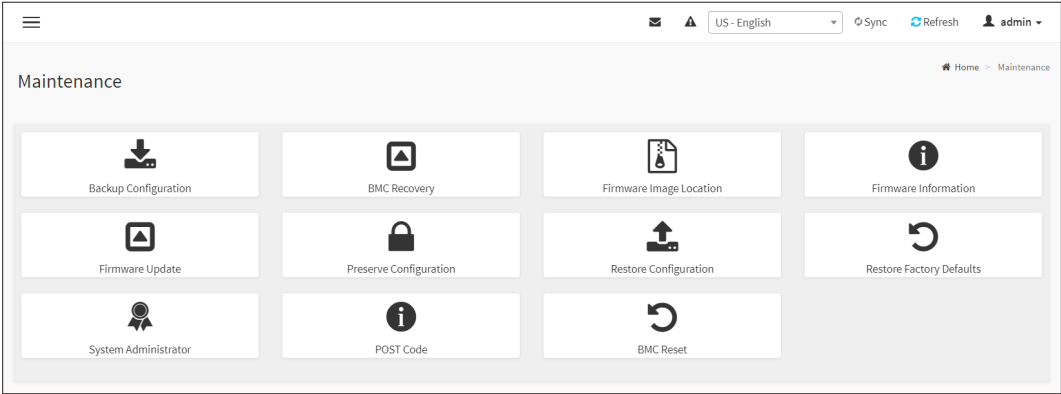

Maintenance

5.2.11.1 Firmware Update

This wizard takes you through the process of firmware upgradation. A reset of the box will automatically follow if the upgrade is completed or cancelled. An option to Preserve All Configuration is available. Enable it, if you wish to preserve configured settings through the upgrade.

Warning: Please note that after entering update mode widgets, other web pages and services will not work. All open widgets will be closed automatically. If upgrade process is cancelled in the middle of the wizard, the device will be reset.

NOTE

The firmware upgrade process is a crucial operation. Make sure that the chances of a power or connectivity loss are minimal when performing this operation.

Once you enter into Update Mode and choose to cancel the firmware flash operation, the Mega-RAC® card must be reset. This means that you must close the Internet browser and log back onto the MegaRAC® card before you can perform any other types of operations.

Once Firmware upgrade using web is started, the regular IPMI command will not be allowed for safety concern if Enable IPMI Command handling during flashing support is disabled in project configuration.

To configure, choose [Firmware Image Location](#) under Maintenance. To open Firmware Update page, click [Maintenance](#) → [Firmware Update](#) from the menu bar.

Procedure

1. Click [Browse](#) to select firmware image.

NOTE

A file upload pop-up will be displayed for http/https but in the case of tftp files, the file is automatically uploaded displaying the status of upload.

2. Click [Start firmware update](#) to load the Firmware Update information. A sample screenshot is displayed below.

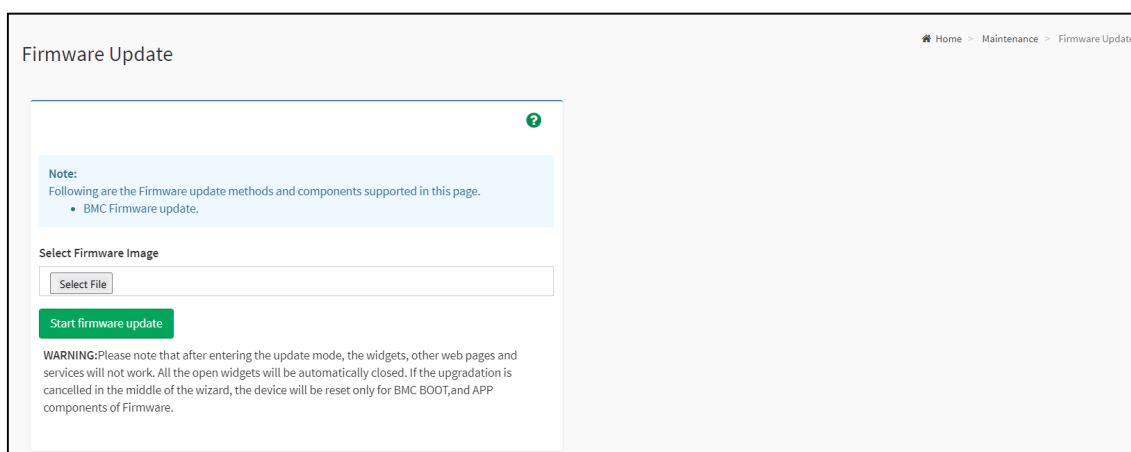

NOTE

SignImage Public Key is feature based option. If encrypted Signimage feature is enabled, then support to Upload a public.pem key info option will be available.

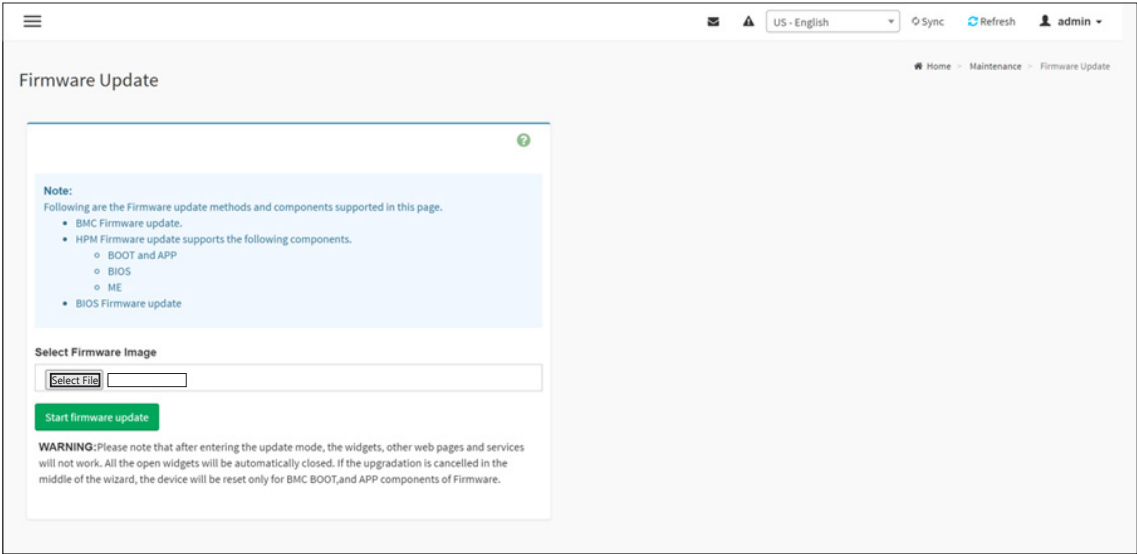

Firmware Update Page

3. Click [Preserve all Configuration](#) to preserve all configuration.
 - **Preserve all Configuration:** To preserve all configuration.
 - **Edit Preserve Configuration:** To modify the Preserve status settings.

This wizard takes you through the process of AMI based firmware upgradation. The protocol information to be used for firmware image transfer during this update is as follows.

NOTE

All configuration items will be preserved/overwrite as default during the restore configuration operation.

4. Click [Proceed to Flash](#), it will prompt you with the warning message. Click [Ok](#) to start the Firmware update.

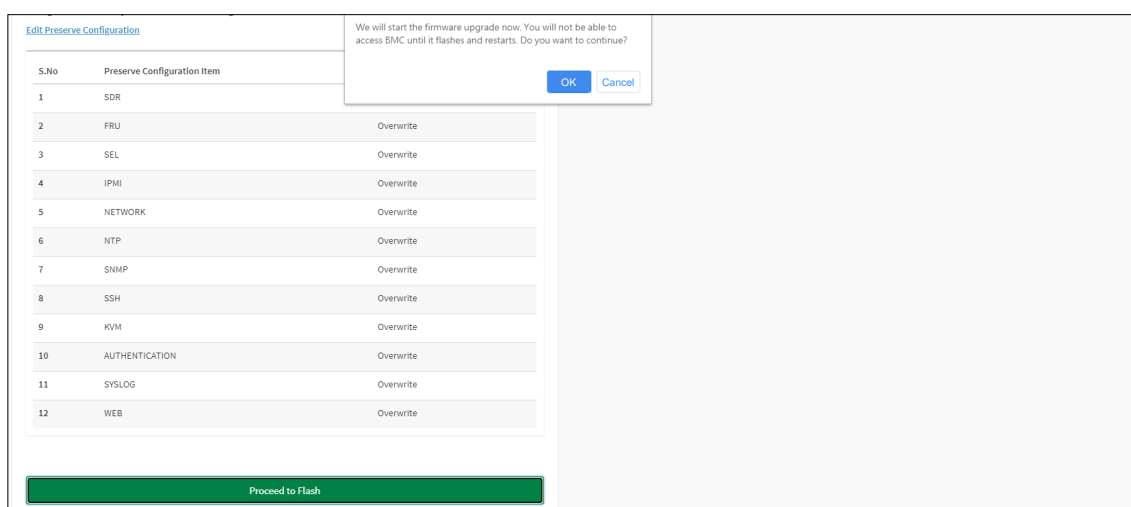

5. The Firmware update undergoes the following steps:
 - a. Closing all active client requests
 - b. Preparing Device for Firmware Upgrade
 - c. Uploading Firmware Image.

A sample screenshot is shown as below.

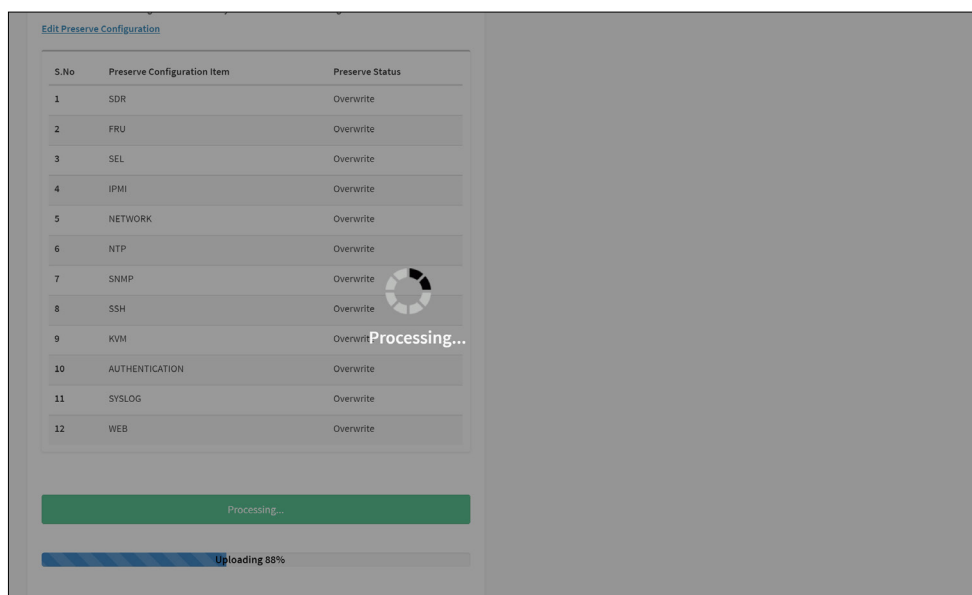

d. Verifying Firmware Image

In Section Based Firmware Update, you can configure the firmware image for section based flashing. Check the required sections and click **Proceed** to update the firmware.

If flashing is required for all images, select the option Full Flash .

If you select Version Compare Flash option from web, the current and uploaded module versions, FMHlocation, size will be compared.

If the modules differ in size and location, proceed with force firmware upgrade.

If all the module versions are same, restart BMC by saying all the module versions are similar.

If only few module versions are differ, those module will be flashed.

NOTE
Only selected sections of the firmware will be updated. Other sections are skipped. Before starting flash operation, you are advised to verify the compatibility between image sections.

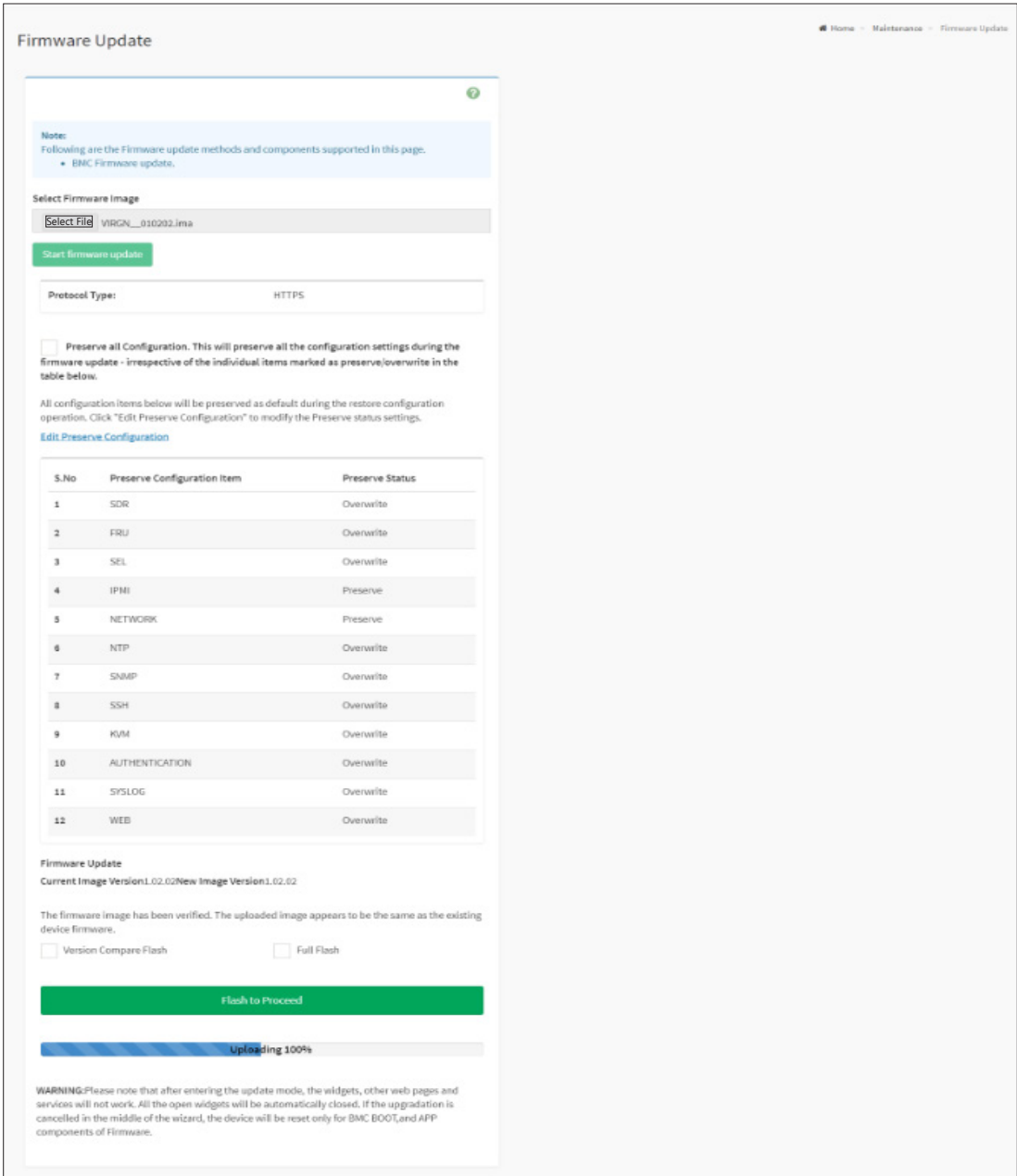

- e. Flashing Firmware Image
- f. Resetting the image. The sample screenshot of Firmware update is as shown below.

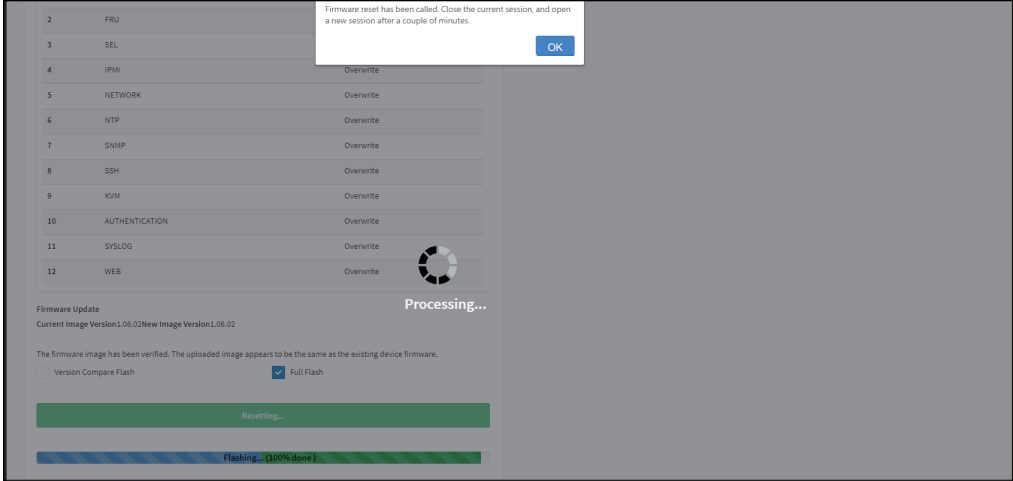

NOTE
The Firmware Update page will be disabled and you will not be able to perform any other tasks until firmware upgrade is completed and the device is rebooted. You can now follow the instructions presented in the subsequent pages to successfully update the card's firmware. The device will reset if update is canceled. The device will also reset upon successful completion of firmware update.

5.2.11.2 BIOS Firmware Update

This wizard takes you through the process of host BIOS firmware upgradation. A screenshot of BIOS Firmware Update is as shown below.

To perform BIOS Firmware Update operation, click [Maintenance](#) → [Firmware Update](#) from the menu bar. A sample screenshot is displayed below.

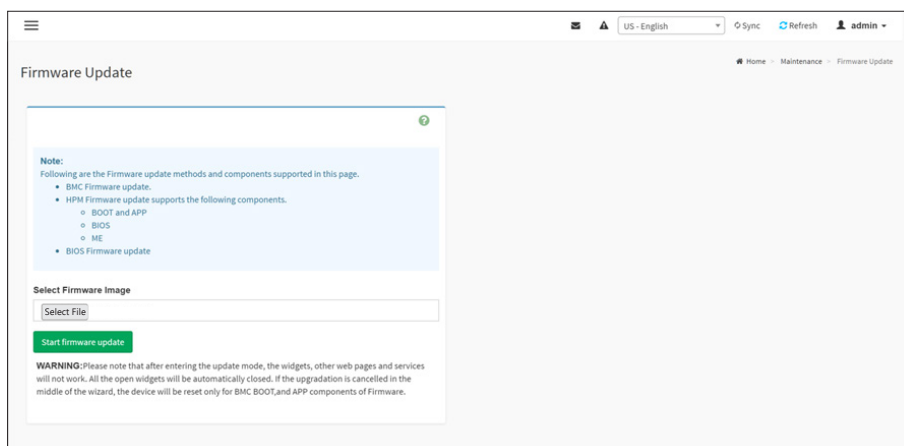

BIOS Firmware Update

Procedure

1. Click [Browse](#) to select BIOS Firmware image.

NOTE

Firmware update wizard will detect .bin extension as BIOS firmware image.

2. Click [Start Firmware Update](#) to load the BIOS firmware image information. A sample screenshot is displayed below.

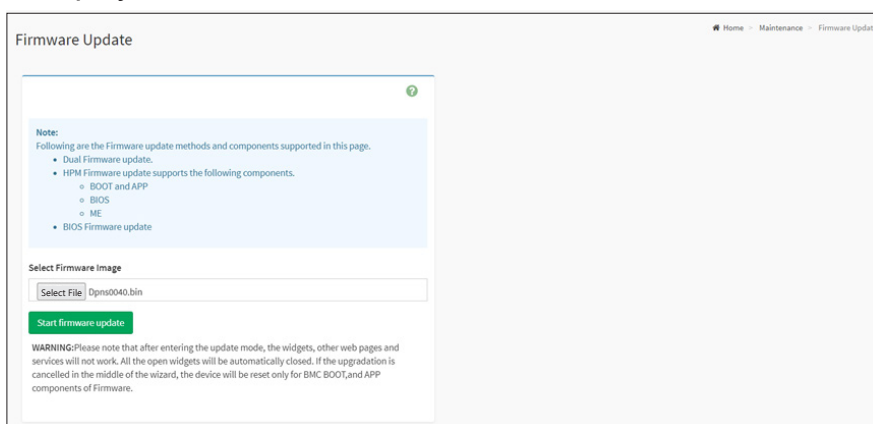

NOTE

Once you enter Firmware update page, an alert message will pop up if the system is on. The wizard will activate the update process after the user powers off the system.

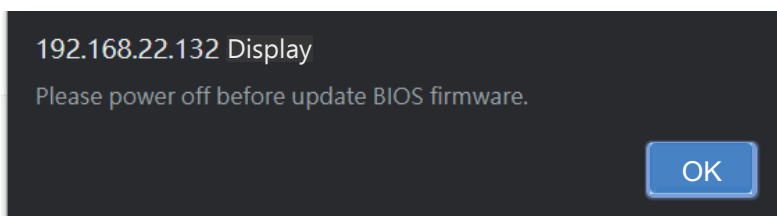

Firmware Update Home -> Maintenance -> Firmware Update



Note:
Following are the Firmware update methods and components supported in this page.

- Dual Firmware update.
- HPM Firmware update supports the following components.
 - BOOT and APP
 - BIOS
 - ME
- BIOS Firmware update

Select Firmware Image

Dpns0040.bin

WARNING:Please note that after entering the update mode, the widgets, other web pages and services will not work. All the open widgets will be automatically closed. If the upgradation is cancelled in the middle of the wizard, the device will be reset only for BMC BOOT, and APP components of Firmware.

- 3. Click **Proceed**, it will prompt you with the warning message. Click **OK** to start the firmware update.
- 4. The BIOS Firmware Update undergoes the below steps.
 - a. Uploading Firmware Image
 - b. Getting BIOS existing and uploaded versions (BIOS Tag)
 - c. Flashing Firmware Image

A sample screenshot is displayed below.

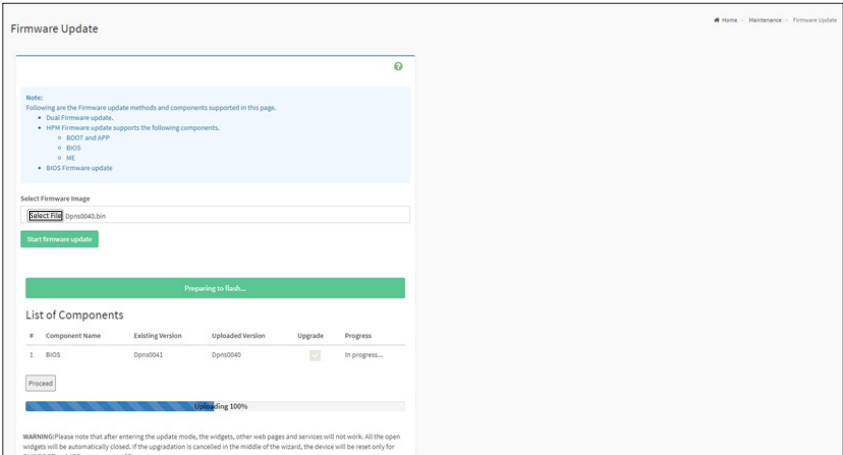

BIOS Image Flashing

NOTE
The BIOS Firmware Update page will be disabled and this action will not allow the user to perform any other tasks until firmware upgrade is completed.

- 5. Once the BIOS firmware update is completed, it will prompt you with the success message. Click **OK** to complete the process. A sample screenshot is displayed below.

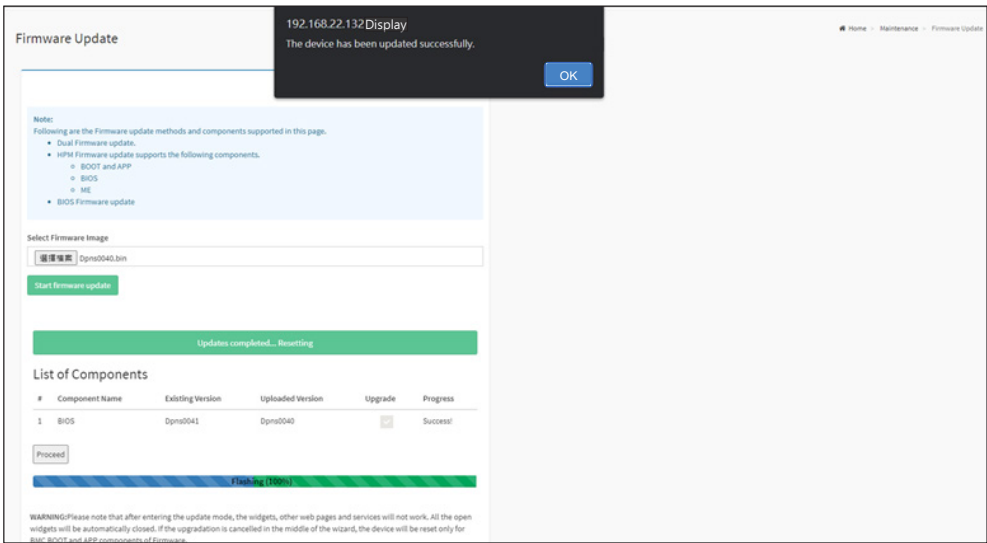

BIOS Firmware Update Success Message

5.2.12 Sign Out

To log out from, click the [admin](#) on the top right corner of the screen. A sample screenshot of admin option is shown below.

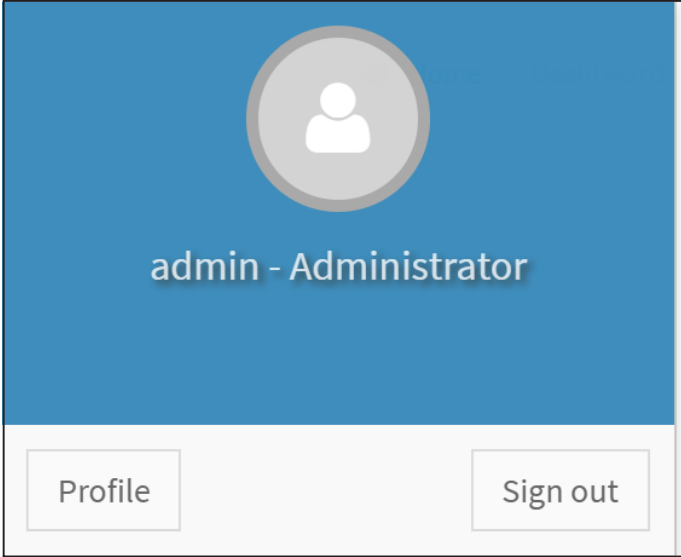

Click [Sign Out](#) to perform log out. A Warning message will be prompted you to proceed further, click [OK](#) to log out or [Cancel](#) to retain the interface.

Chapter 6. Technical Support



www.aicipc.com

Taiwan, Global Headquarters

Address: No. 152, Section 4,
Linghang N. Rd, Dayuan District,
Taoyuan City 337, Taiwan
Tel: +886-3-433-9188
Fax: +886-3-287-1818
Sales Email: sales@aicipc.com.tw
Support Email: support@aicipc.com

Shanghai, China

Address: Room 215, Building 4, No.471
Guiping Road, Xuhui District,
Shanghai City, 200233 China
Tel: +86-21-54961421
Sales Email: sales@aicipc.com.cn
Support Email: support@aicipc.com

Moscow, Russia

Address: No. 500, 5th Floor, 5th Entrance,
32A, Khoroshevskoye Shosse, Moscow,
123007
Tel: +7-4997019998A
Sales Email: support-ru@aicipc.com.tw
Support Email: rma.russia@aicipc.com.tw

North California, United States

Address: 48531 Warm Springs
Boulevard Suite 404 Fremont, CA
94539, United States
Tel: +1-510-573-6730
Sales Email: sales@aicipc.com
Support Email: support@aicipc.com

South California, United States

Address: 21808 Garcia Lane
City of Industry, CA 91789,
United States
Toll free: + 1-866-800-0056
Tel: +1-909-895-8989
Fax: + 1-909-895-8999
Sales Email: sales@aicipc.com
Support Email: support@aicipc.com

New Jersey, United States

Address: 322 Route 46 West Suite 100
Parsippany, NJ 07054 United States
Tel: +1-973-884-8886
Fax: +1-973-884-4794
Sales Email: sales@aicipc.com
Support Email: support@aicipc.com

Houten, The Netherlands

Address: Peppelkade 58, 3992AK, Houten,
The Netherlands
Tel: +31-30-6386789
Fax: +31-30-6360638
Sales Email: sales@aicipc.nl
Support Email: support@aicipc.com

For additional technical support or questions about trouble shooting, please contact the AIC® representative nearest to you or visit our AIC® website for more information.
AIC® website: <https://www.aicipc.com/en/faq>.